

HEATWAVE

WARM IT UP WITH A FREE SOURCE OF HEAT!

MULTI-FUEL UNIT HEATERS



HW150 HW250 HW350

Siebring Manufacturing, Inc.

303 S. Main St. PO Box 658

George, IA. 51237

Ph. 712-475-3317

Fax 712-475-3490

www.siebringmfg.com

TABLE OF CONTENTS

IMPORTANT NOTES – PLEASE READ	1
Warranty Policy and Conditions that Void the Warranty	1
Preface	1
TABLE OF CONTENTS	1-5
1.00 WARNINGS & WARRANTY	6-9
Letter from Kagi Heating & Supply	10
2.00 GENERAL OPERATION: How a HEATWAVE Furnace Works	11
3.00 OVERVIEW: Furnace Controls and Operation	12
3.01 Thermostat	13
3.02 Oil Primary Control	13
3.03 Fan Control	14
3.04 Hi-Limit Control	14
3.05 Barometric Draft Control	14
3.06 Atomizing Air Regulator	15
3.07 Oil Preheater	15
3.08 Oil Preheater Thermostat	15
3.09 Air and Oil Solenoid Valve	16
3.10 Cad Cell	16
3.11 Oil Regulator	17
3.12 Air Pressure Switch	17
3.13 Combustion Air, Blast Tube, Air Turret Band Adjuster	17
3.14 Igniter Electrodes	17
3.15 Nozzle	18
3.16 Neon Indicating Lamps	18
3.17 Preheater On / Off Switch	18
3.18 Soft Start Tank (Standard on all KAGI Burners)	19
4.00 INSTALLATION	19
4.01 Consideration for Proper Installation	19
4.02 Required Reference Materials	19
4.03 Introduction	20
4.04 Site Selection Requirements	20
4.05 Installation of Furnace on a Combustible Floor	21
4.06 Installation: Ceiling Requirements	21
4.07 Installing Heater Too High	21
4.08 Ventilation and Combustion Air Requirements	21
4.09 Ventilation and Combustion Air Groupings	21
4.10 Location of Furnace Considering Ventilation & Combustion Air	21
4.11 Air Circulation / Heat Distribution	22
4.12 Minimum Clearances from Combustible	23
4.13 Blower Installation	23

4.14	Burner Installation	23
4.15	Chimney Requirements	24
4.16	Ceramic or Masonry Chimney	25
4.17	Chimney Connector	26
4.18	Chimney Clearance Outdoors	27
4.19	Special Chimney Caps for Down Drafts	27
4.20	Barometric Damper / Barometric Draft Control	27
4.21	Oil Tank Installation / Pump / Piping Section	28
4.22	Furnace and Storage Tank Clearance	28
4.23	Tank Size Selection	28
4.24	Oil Tank Temperatures	29
4.25	Underground Tanks (Use Of)	29
4.26	Vent Pipe for the Storage Tank	29
4.27	Fill Pipe	30
4.28	Tank Venting / Filling Gauge	30
4.29	Tank Agitator (For Mixing Different Viscosity Oils)	30
4.30	Floating Pick-Up Oil Sump (For Dirty Underground Tanks)	30
4.31	Pump Installation and General Pump Information	31
4.32	Optimum Pump Location	32
4.33	Fuel Filter and Location	32
4.34	Piping and Fuel Lines	33
4.35	Pipe Diameter	34
4.36	Pipe Material	34
4.37	Compressed Air Supply	34
4.38	Compressed Air Piping	35
4.39	No Compressed Air Available	36
4.40	Electrical Supply	36
4.41	Electrical Conduit	37
4.42	Electrical Supply: Pump	37
4.43	Pump Connections Form Wiring Schematic	37
4.44	Electrical Wall Thermostat	37
4.45	Ducted Installation	37
4.46	Ducting Pressure and Changes	38
4.47	Louvers (Non Ducted Installations)	38
4.48	Comment on Installation Diagram	38
4.49	Comment on Installation Wiring Diagram	39
4.50	Summary: Installation Instructions	39
5.00	START-UP PROCEDURE	40
5.01	Pump Priming and Additional Start-Up Information	41
5.02	Furnace Smells When First Fired Up	44
6.00	FURNACE ADJUSTMENT AND GENERAL OPERATION GUIDLINE	44
6.01	Furnace Controls Requiring Adjustment	44

6.02	Adjusting the Secondary Air Without a Smoke Spot Tester	45
6.02a	Adjusting the Flame Using the Cad Cell on Furnaces Where There is No Flame Observation Port	45
6.03	Adjusting the Oil Pressure Regulator	45
6.04	Fan Speed	46
6.05	Draft Readings	46
6.06	Power Draft Boosters	47
6.07	Venting all Combustion Air from Outdoors to Overcome Negative Building Pressures	47
6.08	Viewing the Flame from Observation Port	47
6.09	Optimum Flame Length	48
6.10	Flame Length Will Increase On Its Own	48
6.11	Optimum Flame Color	49
6.12	Dark Red / Orange Flame	49
6.13	Over Firing Your Furnace	49
6.14	Adjustable Flow Rate	49
6.15	Filter Waste Oil	49
6.16	Filter Waste Oil Through a Magnet	50
6.17	Adding Thin Fuels to Waste Oil Supply	50
6.18	Burning Rear End Grease	50
6.19	Burning Synthetic, Cooking, and Other Oils	50
7.00	CHECKS AND MAINTENANCE	51
7.01	Maintenance and Service	51
7.02	Stack Temperature for Determining When Dust Clean-out is Needed	51
7.03	Protective Clothing	52
7.04	Dust Removal From 2 nd Clean-out door (CAUTION)	52
7.05	Maintenance Schedule	53
7.06	Seasonal Cleaning	54
7.07	Burner Cleaning	57
7.08	Cleaning Strainer in Waste Oil Transfer Pump	58
7.09	Cleaning the Suction Strainer in the Storage Tank	58
7.10	Cleaning the Oil Filters	59
7.11	Cleaning the Nozzle	59
7.12	DELETED	
7.13	Cleaning Lines, Solenoids, and Preheater Block	60
7.14	Cleaning the Cad Cell	61
7.15	Checking the Cad Cell	61
7.16	Oil Primary Relay Test	62
7.17	Cad Cell Sensor Test	62
7.18	Checking the Blower Pulley	63
7.19	Blower Belt Tension	63
7.20	Removal of Accumulated Excess Oil	63
7.21	Checking the Oil Primary Control	64
7.22	Bleeding the Pump	64
7.23	Checking the Oil Pump Properly	65

7.24	Checking Regulators	66
7.25	Checking Transformer	66
7.26	Checking for Water in Nozzle Discharge Spray	67
7.27	Checking for Water in Oil Supply	67
7.28	Checking for Water in Air Supply	68
7.29	Checking Neon Indicator Lights	68
7.30	Jumping Switches to Check Components	68
8.00	TROUBLE SHOOTING	69
8.01	Seven Common Reasons Why Burner Will Not Ignite	69
8.02	Flooded Furnace	70
8.03	Burner Trouble Shooting	71
8.04	Furnace Fails to Start	72
8.05	Furnace Starts, Burns a Short Time, Then Shuts Down	73
8.06	Furnace Burns With Smoky Flame	74
8.07	Furnace Burns With Long Narrow Flame	74
8.08	Furnace Burns, Flame Has Sparks and “Fireflies”	75
8.09	Flame Impingement	75
8.10	Furnace Burns With Short Flame	76
8.11	Flame Pulsates	76
8.12	Flame Pulsates Now and Then, Especially When It’s Windy and Sometimes Goes Out	76
8.13	Furnace Burns, But Puts Out Low Heat	77
8.14	Flame is Too Short and Gets Shorter When Increasing the Air Pressure, and Then Goes Out	78
8.15	Flame is Hard to Adjust, a Little Turn and It Is Too Much, A Touch Backwards and It’s Too Small	78
8.16	Flame Will Continue When the Inspection Door Is Opened, But Goes Out When It Is Closed	78
8.17	Furnace Burns Too Hot	78
8.18	Furnace Does Not Shut Off	79
8.19	Furnace Runs Well, Then Burner Stops and Blower Blows Cold Air	79
8.20	Furnace Burns, But Rumbles	79
8.21	Furnace Operates, But Smells	80
8.22	Furnace Drips Oil	80
8.23	Furnace Set At Night Is Off By Morning	80
8.24	Furnace Has Excessive Ash Buildup	81
8.25	Furnace Has Black Clinkers In Chamber	82
8.26	Furnace Chamber Flaking Metal	82
8.27	Flame Is Not Burning in the Center of the Baffle Target (See 8.27)	82
8.28	Furnace Baffle Has Burnout Hole or is Loose and Not in the Right Position	82
8.29	Oil Primary Control Trouble Shooting	83
8.30	Oil or Air Solenoids Chatter	83
8.31	Oil Regulator is Noisy	83
8.32	Pump Does Not Work When Burner Comes On	84

8.33	Pump Works, But Runs Hot	84
8.34	Pump Works, But Is Noisy	85
8.35	Pump By-Pass Pressure Too High	85
8.36	Pump Turns, But No Pressure	85
8.37	Pump Has Too High Vacuum Or No Vacuum	86
8.38	Pump Was Working Till the Oil Filters / Screen in the Pump Was Cleaned	86
8.39	No Spark At Electrodes	87
8.40	No Oil Discharge At Nozzles	87
8.41	Deleted	
8.42	No Oil Spray From Nozzle: Due to a Malfunctioning Air Pressure Switch	87
8.43	Burner Has Spark and Oil Spray, Will Not Ignite	88
8.44	Blower Runs Continuously	88
8.45	Furnace Fan Cycles Too Often, Room Is Cold	89
8.46	Continuous Air Flow Out of Nozzle	89
8.47	Continuous Oil Flow Out of Nozzle	90
8.48	Faulty Wall Thermostat	90
8.49	Green Light Comes On and Then Goes Out, After Waiting, Comes Back On	90
8.50	Oil Pressure Gauge on the Burner Starts to Climb When the Burner Shuts Off and Gets So High It Ruins the Gauge	91
9.00	MISCELLANEOUS	92
9.01	Furnace Shut Down for Extended Periods	92
9.02	Operating Furnace On Warm Day To Rid Waste Oil	92
	❖ SUNTEC FACTORY PUMP INFORMATION	
	❖ DELTA FACTORY SERVICE / MAINTENANCE	
	❖ CAUTION DECALS AND NOTES	
	❖ MAINTENANCE SCHEDULE AND DECALS	
	❖ BURNER PARTS LIST (In rear of book, illustrated drawings)	
10.0	Index of Drawings	93

Note: Letter drawings A-F, F(ICM), F-1 & F-2 (figures 33-41) apply to the Kagi S-250 & S-500 burners and are broken down by component to make viewing & wiring easier and less confusing.

IMPORTANT NOTES: PLEASE READ

When the furnace is delivered to you, BE SURE THAT THE FURNACE CABINET AND OTHER BOXES THAT ACCOMPANY IT ARE OPENED AND CHECKED FOR FREIGHT DAMAGES BEFORE THE DRIVER LEAVES as it is easier to file a claim if the driver signs the bill of lading and acknowledges that the furnace is damaged. If there is no time to inspect the shipment, observe outside carton damages and make note of this on the delivery bill of lading. If you do not, you may NOT get full compensation on damages as some freight companies will pay you on "hidden damages" which may be only a partial payment on your loss. Siebring Manufacturing, Inc. carefully inspects and packages furnaces for shipment, and has NOT sent you a damaged one.

Open the boxes and remove the contents and check that you have one of each of the following items:

- A. OWNERS MANUAL
- B. SQUIRREL CAGE CIRCULATION BLOWER
- C. ELECTRIC MOTOR FOR (B)
- D. FAN BELT FOR (B)
- E. SMALL PARTS PACKAGE FOR (B), (B, C AND E MAYBE PREASSEMBLED)
- F. ALUMINUM WASHABLE FILTER & FITTINGS
- G. CHECK VALVE
- H. SUCTION STRAINER
- I. WASTE OIL TRANSFER PUMP
- J. WALL THERMOSTAT
- K. 8 INCH BAROMETRIC DAMPER

**IMMEDIATELY NOTIFY YOUR HEATWAVE DEALER OR SIEBRING
MANUFACTURING OF ANY SHORTAGES**

Siebring Manufacturing, Inc. and our insurance carrier need to know the location of all units sold to assist in handling warranty claims and to disseminate important service bulletins directly to owners.

WARRANTY POLICY

MULTI-OIL FUELED HEATER (LIMITED WARRANTY)

If you are in need of service support and your local dealer or Heatwave representative is not available or cannot help you, contact the Kagi Customer Service Department (888-866-5244) during normal business hours (Pacific Time). Read and check your Heatwave Owner's Manual under "Trouble Shooting" first as your problem may be very simple to solve. As an owner, you can perform a number of checks and maintenance procedures with the assistance of you manual. Before a part is considered defective, a Kagi service technician can help you determine if it just needs cleaning and/or adjustment.

HEATWAVE Warrants to the purchaser of this Multi-Oil Fueled Heater Unit that it will repair or replace any part which in normal use proves to be defective in material or workmanship within a period of ONE (1) YEAR from the date of purchase, provided same is returned for factory inspection and warranty determination. The combustion chamber (Limited Warranty) is warranted for a period of TEN (10) YEARS at a pro-rated schedule, provided the heater is properly installed and maintained.

HEATWAVE does not warrant the paint finish as this is subject to abrasion, scratching, and discoloration during installation and operation. The warranty does NOT cover any labor charges involved with parts replacement or service unless preauthorized by Siebring Mfg., Inc. in writing.

NOTICE: The Heatwave Multi-Oil Fueled Burners, Model HW150, HW250, and HW350 are tested, designed, and listed to burn the following:

- A. USED CRANKCASE OILS UP TO 50 SAE WEIGHT
- B. #2 FURNACE FUEL OILS
- C. USED AUTOMATIC TRANSMISSION FLUID

WARNING: CONDITIONS THAT WILL VOID THE WARRANTY

- A. Using in the heater or adding to the storage tank substances, including, but not limited to the following: paint, thinner, gasoline, other volatile liquids, or solvents, transformer oils, or gear lubes. Some of these substances have a high chloride content which can oxidize HEATWAVE stainless steel targets and chambers. It is illegal to mix any of these substances with waste oil and doing so can cause a hazardous condition.
- B. Tampering with the internal components of the safety switches, air/oil, aluminum preheater, or any parts in general.
- C. Not installing the heater properly as per instruction in this manual and/or according to local and state codes.
- D. Not maintaining the heater according to instructions in this manual.
- E. Abusing or altering any part.
- F. Using parts other than those supplied by Siebring Mfg., Inc. to operate this heater.
- G. Over-firing the heater.

NOTE: Siebring Mfg., Inc. and our insurance carrier need to know the location of all heaters sold in order to distribute service bulletins directly to the owner.

For warranty service, simply contact the dealer from whom the heater was purchased. If the unit was purchased directly from Siebring Mfg., Inc., notify Siebring Mfg., Inc. in writing of any defects. No parts will be accepted for warranty inspection unless Siebring Mfg., Inc. has issued an RGA (Returned Goods Authorization) number. Before this number is given, the part or parts will have been determined by phone to be defective and the model, serial number, replacement part number, purchase date, and nature of defect will be recorded.

This warranty gives you specific legal rights and you may have other rights which may vary from state to state.

PREFACE

All installations must be made in accordance with state and local codes, which vary from state to state, and may differ from this manual.

Heater must be installed and / or inspected by a licensed heating contractor before operation.

IMPORTANT NOTES AND CAUTIONS:

RULES AND REGULATIONS PROMULGATED BY STATE AND LOCAL AUTHORITIES TAKE PRECEDENCE OVER THE GENERAL INSTRUCTION PROVIDED IN THIS MANUAL.

THE INSTALLATION OF THE EQUIPMENT SHALL BE IN ACCORDANCE WITH NFPA (NATIONAL FIRE PROTECTION AGENCY) REGULATIONS OF AUTHORITIES HAVING JURISDICTION OVER ENVIRONMENTAL MATTERS, AND FUEL, FIRE, AND ELECTRICAL SAFETY.

Installation, operation, and maintenance permits from each of the above authorities may be required, as well as municipal permits.

The three Heatwave furnaces Models HW150, HW250, and HW350 are listed with ETL Laboratories, which have tested the U.L. Standards for waste oil burning furnaces. Models HW150, HW250, and HW350 are listed to use #2 furnace fuels, automatic transmission oils, and used crankcase oils up to 50 SAE.

CAUTION: NOT FOR RESIDENTIAL USE!

CAUTION: DO NOT BURN GASOLIN OR ADD GASOLIN TO THE FUEL SUPPLY!

CAUTION: DO NOT TRY TO BURN CLEANING FLUIDS, PAINT THINNERS, OR OIL ADDITIVES IN THIS APPLIANCE!

CAUTION: DO NOT PUSH THE RESET BUTTON ON A FLAMEOUT IF THE FURNACE IS HOT TO THE TOUCH AND FILLED WITH OIL VAPORS OR FUMES!

CAUTION: DO NOT STORE OR USE GASOLINE OR OTHER FLAMMABLE LIQUIDS NEAR THIS FURNACE!

CAUTION: KEEP THE FUEL VALVE NEAREST THE SUPPLY TANK SHUT OFF WHEN THE BURNER IS SHUT DOWN FOR EXTENDED PERIODS!

CAUTION: DO NOT INSTALL THE FURNACE OR BURNER ON OR NEAR COMBUSTABLE MATERIALS! (See instructions for minimum distances.)

CAUTION: IF YOU TURN OFF THE POWER TO THE BURNER, FOR ADDED SAFETY, TURN TO “OFF” OR OPEN THE CIRCUIT TO THE WALL THERMOSTAT.

CAUTION: DO NOT TAMPER WITH THE CONTROLS; CALL YOUR TECHNICIAN!

CAUTION: THE EXHAUST STACK MUST BE CLEANED ANNUALLY!

CAUTION: WASTE OILS CAN CONTAIN POISONOUS HEAVY METALS AND OTHER FOREIGN MATERIALS. WHEN BURNED, THESE COMPOUNDS ARE DEPOSITED WITHIN OR EMITTED FROM THIS HEATING APPLIANCE AND THEREFORE CARE SHOULD BE TAKEN WHEN USING, CLEANING, AND MAINTAINING THIS EQUIPMENT!

CAUTION: WHENEVER ANY CLEANING, INCLUDING THAT OF THE FLUE AND EXHAUST STACK IS DONE, PROTECTIVE CLOTHING, INCLUDING GLOVES AND A FACE MASK OR RESPIRATOR, MUST BE WORN!

.From Kagi Heating & Supplies:

THANK YOU for selecting a HEATWAVE MULTI-FUELED FURNACE. Your furnace may come to you unassembled to reduce shipping damage. This furnace will be simple to assemble – just follow the instructions in this manual. It will be operational in a short time. NOTE: The Heatwave furnace maybe shipped to you already assembled. Proper installation is extremely important for safe, reliable operation of the Heatwave furnace. Simple maintenance on the furnace must be performed periodically or the furnace will not start properly and components of the furnace will fail, leading to premature replacement of parts. MOST COMPLAINTS about waste oil furnaces, regardless of the manufacturer, are due to improper installation and maintenance. HEATWAVE furnaces all have standard UL-listed safety devices that are used in residential oil furnaces and all models Siebring Mfg., Inc. manufactures are engineered to operate on a negative draft. Should the chamber leak, all obnoxious gases will be vented up the chimney, not into the room. An UL-listed electric eye monitors flame, and should a flameout occur the burner will shut down immediately. Should the circulation blower fail, a hi-limit switch set at 200° F. will immediately shut off the burner which will not start again on its own, but must be reset.

I have installed, investigated, and field-checked hundreds of waste oil furnaces and I urge reading this manual very carefully before installing and operating your HEATWAVE furnace. Your reward will be a furnace that eliminates your waste oil problems, and saves you up to hundreds of dollars each month during the heating season.

Tom Kagi Sr.
Sales / Engineer

2.00 HOW A HEATWAVE FURNACE WORKS:

When the HEATWAVE furnace is energized from an electrical service panel, the current goes directly to the High-Limit micro switch in the High-Limit fan switch. This is a normally closed switch, and from there it goes to the burner. Inside the burner is an aluminum heat sink block, which begins to heat. This aluminum heat sink houses two electrical heating elements. The larger wattage heater (250 watts) is always on and preheats the air for atomization and helps heat the waste oil contained in this aluminum block. The lower wattage heater (50 – 100 watts) is the oil pre-heater and is installed in the oil passage within the aluminum block. This heater is energized only when the burner is operating and heats the oil prior to entering the nozzle. This aluminum block is kept at approximately 160° F. by a thermostat contacting the aluminum block.

There is normally open snap thermo-disc, which closes on temperature rise. When this thermo sensor closes, it energizes a green neon indicator light on the burner which signals the burner has preheated the oil to ignition temperature, and the burner is ready to fire.

When the wall thermostat is turned up above ambient temperature, and the points in the thermostat are closed, calling for heat, a jump connection is created between the two TT terminals on the oil primary control and the primary control load wire is activated sending power to all of the burner components. The combustion blower now comes on, air pressure is sensed on the air pressure switch sends power to the fuel pump. The air and oil solenoid valve is normally closed and when it receives current, it opens; allowing air to be pushed out from the nozzle with compressed air and through venture action, oil is allowed to flow and sprayed into the firing chamber.

A 14,000-volt transformer is energized, always sparking while the burner is on, producing a hot, constant, electrical spark. The combustion air in the blast tube blows into this blue spark, lengthening it, and moves this arc into the oil spray igniting it.

The waste oil is sucked out, from the aluminum block by a special nozzle using compressed shop air or an optional remote air compressor. This nozzle has a large discharge orifice to allow large colloidal matter suspended in waste oil to pass through. Inside this special nozzle is an oil distributor which spins the oil and air out into microscopic droplets to allow a complete burn. When the oil primary control is energized, a normally closed oil solenoid is energized open, and oil flows into the block from a remote gear-driven pump. The pump receives current from an air pressure switch, which closes at approximately at 9 PSI, which delivers oil from the oil storage tank through a 100-micron filter directly to the burner. This pump is always working when the burner is firing and stops when the burner cycles off. The smaller wattage element

heater in the aluminum heat sink block is connected to the oil primary circuit and when energized, starts to heat the oil. This oil heater turns on and off when the burner is cycling. This unique feature is the reason KAGI burners are so reliable. Others on the market keep a constant high temperature on the oil, and when these heaters are left on for extended periods of time, the oil will carbon and coke up in the pre-heater.

The KAGI burner has a variable oil regulator, which allows a variety of different-viscosity oils to be burnt hence the variable BTU output. It can burn from ONE HALF of a gallon to FOUR gallons per hour, depending on the size of the nozzle used and the adjustment set on the burner.

When ignition is established, important adjustments to the blast tube air (combustion air) oil pressure, oil flow, and air for atomization must be made for a clean burn.

When the proper adjustments are made, the oil burns with a clean, extremely hot, yellowish-orange flame. The retention-head theory is utilized in the KAGI burner by spinning the heavier droplets of waste oil together, making a complete burn. When the burner is operating for a while and the cabinet air reaches a preset temperature, a fan switch automatically turns the circulation blower on, forcing heated air into the room. A UL-listed cadmium sulfide cell, or “electric eye”, monitors the flame and should a flame-out occur, this safety switch turns the burner off immediately.

Should circulation blower fail, an UL-listed safety cabinet switch will automatically turn off the burner when it reaches 200° F.

The heated air from the burner passes to the end of the combustion chamber, and is directed to the opposite end of the chamber, making a total of three passes before it exits out the chimney stack. This reduces the stack temperature, and makes your HEATWAVE furnace one of the most thermo-efficient furnaces on the market.

3.00 OVERVIEW: FURNACE CONTROLS AND OPERATION

The following is a list of furnace controls:

1. THERMOSTAT
2. OIL PRIMARY CONTROL
3. FAN CONTROL
4. HI-LIMIT CONTROL
5. BAROMETRIC DRAFT CONTROL
6. AIR REGULATOR
7. OIL PREHEATER
8. PREHEATER THERMOSTAT
9. OIL SOLENOID
10. AIR SOLENOID
11. CAD CELL
12. OIL REGULATOR

13. AIR PRESSURE SWITCH
14. PREHEATER THERMOSTAT (snap disc)
15. PREHEATER ON/OFF SWITCH
16. AIR TURRET BAND ADJUSTER
17. IGNITOR ELECTRODES
18. NOZZLE

3.01 THERMOSTAT

The wall thermostat controls the operation of the automatic furnace to keep room temperature within a desired range. The thermostat should be located approximately five feet above the floor, in a central location with good natural air circulation. Avoid placing the thermostat near opening doors or other sources of draft (including duct flow). The thermostat will not operate properly unless it is mounted level.

The thermostat has a heat anticipator that artificially supplies heat to the sensing element while the burner is operating. The anticipator prevents the room temperature from exceeding the desired setting.

Follow the manufacturer's instructions for installation and adjustment. An anticipator setting of 0.2 should be used for the Carlin 48245S primary. The wall thermostat should not be installed where it may be affected by drafts or flow from air ducts.

3.02 OIL PRIMARY CONTROL

The oil primary control is the gray or black rectangular box sitting on the top right side of the burner. It has a red reset button on the top of the control (see figure 11).

When the wall thermostat is set for a temperature above the ambient temperature of the room, the oil primary control starts the burner by switching on various components. A cadmium sulfide cell, "electric eye" monitors the light level in the combustion chamber to ensure there is fire. After 45 seconds, if there is no fire, the primary control shuts the burner down. The burner will not restart unless the control is reset. Should the fire go out at any time during operation, the oil primary control will automatically stop the burner.

If fuel is not being ignited, this control precludes the burner from operating thereby, preventing fuel from being sprayed into the combustion chamber.

CAUTION!! If a jumper wire is placed across the FF terminals on the oil primary control, once the oil burner is started, the oil burner will continue to run, with or without flame ignition. The cad cell switch is normally open, which means at room temperature and without outside influence, it has no current continuity. The cad cell functions as a jumper wire across the FF terminals. If the burner does not function without the jump cable, stop and determine what the problem is. (See index of drawings for illustration).

CAUTION!! OPERATING THE BURNER WITH THE JUMPER WIRES ATTACHED TO THE FF TERMINALS IS NOT RECOMMENDED AS THIS RESULTS IN BY-PASSING THE OIL PRIMARY CONTROL, AN IMPORTANT SAFETY DEVICE THAT IS DESIGNED FOR YOUR PROTECTION!

NOTE: The burner must be started first before the jump cable is attached, as attaching the jump cable first will make the burner unable to start!

CAUTION!! DO NOT PRESS THE RESET BUTTON IF THE FURNACE IS HOT TO THE TOUCH. ALLOW THE FURNACE TO COOL AND DO NOT PRESS THE RESET BUTTON MORE THAN TWICE. (If the burner fails, check the “TROUBLE SHOOTING” section and /or call your service attendant or service organization or KAGI’S Customer Service Department.

3.03 FAN CONTROL

The fan control is a silver-colored rectangular box with a plastic push-and-pull button that monitors the temperature of the air moving over the heat exchanger. When this temperature reaches 120° F.*, the blower fan activates, distributing heat to the building. After the burner shuts down, the blower operates until the temperature reaches approximately 90° F.*. These temperatures are factory set and may require field adjustments. To turn the fan on sooner, adjust the “ON” tab of the fan control to a lower temperature. To run the fan longer after the burner shuts off, adjust the “OFF” tab of the fan control to a lower temperature. (See figure 29 for illustration)

The plastic “Auto” or “Manual” button on the fan control is usually left in a pulled-out position, which is “automatic”. When this button is pushed in to the “Manual” position, the blower fan will come on immediately and stay on. This is the “summer fan” position for air circulation during the warmer months. Figure 30-31.

****THESE TEMPERATURE SETTINGS MAY BE ADJUSTED UP OR DOWN.***

3.04 HI – LIMIT CONTROL

The Hi-Limit control resides in the same unit as the fan control. It is a separate micro-switch with its own circuitry. Normally set at 170°F, the limit will shut the burner down when the temp setting is met. An additional safety control shuts down the burner if the outlet air temperature exceeds a factory setting of 200° F., thereby, monitoring such problems as overheating caused by a blower motor failure, loose or broken fan belt, blockage of the ductwork, or other circulation related problems.

3.05 BAROMETRIC DRAFT CONTROL

The barometric draft control automatically prevents the draft in the combustion chamber from exceeding a pre-set level by killing or reducing the draft in the event the weather conditions cause a drop in the barometric pressure outside, WITHOUT this control a

fluttering flame or a serious flameout could occur. By building code, this control must be installed!

A barometric draft control designed for oil burners must be installed in the flue pipe close to the furnace, preferably in the first section of pipe. **CAUTION: DO NOT USE A WOOD BURNING DRAFT CONTROL** as they are different from models used for oil furnaces. The opening in the flue must be the full sized of the collar of the draft control. Use a spirit level to ensure that the control does not lean backward or forward and that the hinge is level. Be sure that it does not stick and is able to swing freely. Operate the furnace at least 30 minutes before adjusting the draft control with a draft gauge. Be sure it is adjusted to obtain top performance from your furnace. Excessive draft could cause low carbon dioxide readings and excessive heat to leave through the chimney. (See section 6.05 on Draft Readings)

3.06 ATOMIZING AIR REGULATOR (see figure 14)

The air regulator is located on the left side of the burner and controls the pressure of the atomizing air reaching the nozzle. This air is necessary for operation of the special, low-pressure nozzle; it sucks the oil out and breaks it into microscopic droplets. Too much air pressure will prevent ignition and cause flameout, and too little air pressure will cause an oxygen-starved, smoky flame. The adjustments will vary depending on the viscosity of the oil, burning rate, altitude and location of the furnace. Set air pressure to 12 PSI or above. The air regulator has a water separator and water drain on the filter bowl.

3.07 OIL/AIR PREHEATER WITH ON/OFF SWITCH (see figure 6)

Waste oil is preheated within this aluminum block at a thermostatically set temperature when the on/off switch is activated. It can be turned OFF when furnace fuels that **DO NOT NEED HEATING** are to be burned. The air for atomization is also heated in this block for ignition. The temperature can be raised or lowered for different viscosity oils by adjusting the preheater thermostat. The thermo-sensor contacts the aluminum block on the outside and regulates the temperature at its setting. Aluminum transfers heat very quickly and uniformly through this block. There are less than two ounces of oil in the oil cavity that is heated, and the oil passages in the block are engineered to move the oil quickly at a speed preventing the oil from jelling inside the block. The aluminum block in the KAGI burner very seldom requires cleaning.

3.08 PREHEATER THERMOSTAT (see figure 36 drawing D)

Used crankcase and automotive transmission oil require preheating. The thermostat controls the temperature of the aluminum block which preheats the oil, approximately 140°F. The oil heater comes on when the burner is called to heat and further raises the temperature of the oil. The oil temperature should not be set higher than what is required for ignition. The higher the oil preheat temperature, the more coking and sludging will occur. If the temperature is set higher than factory recommendations to burn thick oils, the preheater should be turned down or off when the burner is not being used to minimize

coking and sludging. KAGI preheaters can be disassembled and cleaned if necessary. (See “Cleaning the Preheater Block”). # 1 & # 2 furnace fuels do not require preheating. The thermostat should be deactivated by turning the preheater switch off! (Located to the left side of front panel of the burner).

3.09 AIR AND OIL SOLENOIDS (see figure 17)

The air and oil solenoid valves on the KAGI burners are actually the same parts. Both solenoids are energized by the load wire from the primary control. They are magnetically normally closed switches, which open when current flows to them. There is an internal piston with rubber disk on the end of the piston that seals an orifice; it is actuated by a spring on the opposite end of the piston. There is an arrow stamped in the casting pointing to the flow direction and this pressure ensures no leakage by helping push on the piston. The current energizes a coil surrounding the metal piston, snapping it up with the magnetic field it creates. The solenoid stops the airflow when the burner stops. On the oil pressure side, this valve stops the oil flow from feeding the fire and eliminates nozzle dripping from residual oil in the delivery system.

CAUTION!! DO NOT TURN BURNER ON WITH THE ELECTRICAL SPOOLS(coils) OFF THE VALVE BODY OF THE SOLENOIDS WHEN YOU ARE CHECKING, AS IN A FEW SECONDS THEY CAN BURN UP. REASON: THE SPOOLS (coils) ARE A DEAD SHORT AND METAL CONDUCTING CORE MUST BE PLACED IN THE MIDDLE TO ABSORB THE ELECTRICAL ENERGY.

3.10 CAD CELL (see figure 38 Drawing F)

The cad cell is located underneath the ignition transformer, with its lens pointed toward the combustion chamber. It has two distinct yellow wires extending from it to the FF terminals on the oil primary control. The cad cell is a safety switch, which is normally open. Light causes continuity between the two yellow wires. When light is directed to this switch through the lens, it acts as a closed jumper between the FF terminals.

The cad cell has a light-sensitive “electric eye” that detects the presence of a flame in the combustion chamber. It is a safety device that ensures the furnace will shut down if the flame goes out. If there is burning in the combustion chamber prior to ignition, the cad cell will not allow the primary control to start the burner. If the burner is bench-tested and light is allowed into the cad cell, the burner will not start unless the cad cell is momentarily shaded.

The cad cell is a resistor that varies its electrical resistance according to the amount of color and light it senses. It acts as a switch when it sees the light of an oil flame. When the cad cell senses light, it has a very low resistance and conducts electricity. When it conducts electricity, the energy pulls in a sensitive relay, which closes a set of points in the oil primary control. When exposed to darkness, the cad cell has a very high

resistance and current will not pass through it, thereby permitting the safety switch to trip open.

The cad cell is sensitive to white, orange, and yellow flames, but not to a blue flame. While a stack-mounted control relies upon the heat from the fuel used for operation, a cad cell control depends upon the light from the oil flame.

The main requirements for efficient operation are:

1. Sufficient direct light sensed by the cell.
2. Location where temperatures do not exceed 140° F.

3.11 OIL REGULATOR (see figure 15)

The oil regulator is located on the right side of the burner in the center of the front control panel. The oil regulator differs in appearance from the air regulator as it does not have the filter bowl/water separator. The oil regulator controls the pressure and the flow rate of the oil that is being burned. The burning rate can be increased or decreased by simply turning the screw on the regulator. The pressure will vary depending on the viscosity of the oil, even if the flame length is the same. It is **IMPORTANT** that the flame is not increased to a point where the target and chamber becomes red hot. With extremely light fuel oil, such as #1 and #2 furnace fuels, under warm ambient conditions, a reading may hardly exist. This is normal and nothing to worry about. The oil regulator may be disassembled and cleaned if necessary. (See figure 15)

3.12 AIR PRESSURE SWITCH (see figure 33 Drawing A)

This is a small micro-switch plumbed to the right side of the aluminum pre-heater block. The electrical box lid (under primary control) must be hinged open to gain access to the switch. It is a normally open switch that closes when the air pressure exceeds 9 PSI. When closed, the switch energizes the remote fuel pump.

3.13 COMBUSTION AIR, BLAST TUBE, AIR TURRET BAND ADJUSTER

This adjusting band is located opposite the burner motor on the round part of the burner housing. It consists of a thin metal band with a bolt and screw to friction lock it on the housing. Moving and aligning the holes with the opening in the burner housing admits more air into the blast tube. Closing the openings will admit less air into the blast tube to the point no air is allowed to enter. This band covers the air entering the squirrel cage fan for combustion and can be adjusted to provide maximum heat and carbon dioxide readings, as well as, lower stack temperature. (See Figure #6)

3.14 IGNITOR ELECTRODES (see figure 13)

A 14,000-volt constant duty transformer is always arcing when the burner is operating. The electrodes and porcelain insulators must be cleaned and free of cracks that will cause

grounding of the spark. The gap between the electrodes must be less than the air gap between each electrode and the ground, otherwise electricity will be routed towards the ground, preventing ignition. If the spark is shorting to the nozzle or retention head, it can burn and ruin them. (See figure #13)

3.15 NOZZLES (see figure 12)

The siphon nozzles on the KAGI burners are of a special low-pressure design and consist of a head/cap, oil distributor, stem, and “O” ring. Compressed air enters the fluted stem and by Venturi design, sucks oil out of the center of the stem where the oil flows. The distributor spins the air and oil into a fine mist to create an efficient complete burn. (See figure #12). Typical nozzles: HW150 = 609.5, HW250 = 609-7/8, HW350 = 609-9

NOTE: The nozzle should be inspected annually and replaced as necessary for best performance as the colloidal abrasive material in waste oil could wear the orifice into an oblong shape, resulting in flame impingement and hard ignition.

3.16 NEON INDICATING LAMPS (see figures 33A & figure 35C)

The neon lamps are on the burner face to indicate which electrical functions are operating.

Red Lamp On: The burner is energized and caution must be taken when servicing anything on the burner.

Green Lamp On: Indicates the pre-heater is on and at the right preset temperature. The green light will not come on when the burner is first turned on as a temperature sensor interrupts its continuity, which is normally open. At approximately 120° F., it closes and the green lamp will come on. When burning waste oil and the burner is first turned on, it is necessary to wait at least 15 minutes and allow the preheater to reach its preset temperature. Do not attempt to start the burner until the green lamp is on.

Amber Lamp On: The remote pump is energized. The amber light will illuminate and go out anytime the pump is energized manually or automatically.

White Lamp On: The oil pre-heaters are turned off and you cannot burn cold waste oil. The multi-fueled Kagi burner will burn waste and furnace fuels; however, it is important to turn the pre-heater off when burning furnace oils. Furnace oils should not be preheated.

3.17 PREHEATER ON/OFF SWITCH

This toggle switch placed to the left of the neon indicating lamps turns the preheater on to heat the waste oil and of (center position of the toggle switch) when burning furnace fuels

that require no preheating. Waste oil must be heated to a certain temperature to ignite. This switch will manually turn the pre-heater on and off. If this switch is mistakenly left off when waste oil is introduced into the burner, the burner will not ignite. The very downward position of this triple position switch is to manually turn the pump on to bleed air out of the fuel lines.

CAUTION!! DO NOT OPERATE YOUR FURNACE WITH THIN FURNACE FUELS WITH THE PREHEATER ON!

The KAGI burner has not been designed to burn anything lighter in viscosity than furnace fuels; therefore, it is NOT necessary that this switch be left on to preheat the oil when burning #1 and #2 furnace fuels as the lessened viscosity from heating will greatly increase the fuel flow.

3.18 SOFT START TANK (standard on all KAGI burners)

The soft start tank illustrated in drawing figure #6 is a miniature air tank placed between the air shut-off solenoid and the discharge nozzle on the KAGI burners. The purpose of this tank is to interrupt the air pressure flow to the nozzle. The air enters this tank and tries to pressurize this small tank, allowing the air discharging from the nozzle to come out gradually, enriching the oil-to-air mixture. A higher fuel to air mixture ignites better, resulting in a reliable burner that ignites every time, wherever the air pressure may be set. Generally, if a waste oil burner doesn't have this tank, and the burner is adjusted to a leaner mixture; it will burn clean and hot, but will usually not re-ignite when it cycles off. There is a small stainless steel drain screw on the bottom of the tank that should be periodically drained to keep its volume from being decreased by any water or fluids that could leak into the tank. The soft start tank and kit can be purchased separately from KAGI manufacturing and installed on any waste oil burner to improve its performance.

4.00 INSTALLATION

4.01 CONSIDERATIONS FOR PROPER INSTALLATION

The considerations for proper installation include:

1. Mounting burner
2. Mounting circulation blower (may come already installed)
3. Oil tank and fuel line piping
4. Chimney
5. Clearances
6. Compressed air supply
7. Electrical supply
8. Air circulation
9. Wall thermostat location

4.02 REQUIRED REFERENCE MATERIALS:

The installer of heating equipment in the United States must consider requirements in the various National Fire Protection Association Code reference books.

1. NFPA 30 “FLAMMABLE AND COMBUSTIBLE LIQUID CODES”
2. NFPA 31 “INSTALLATION OF OIL BURNING EQUIPMENT”
3. NFPA 70 “NATIONAL ELECTRICAL CODE”
4. NFPA 80 A&B “REPAIR GARAGES AND PARKING STRUCTURES”
5. NFPA 90B “WARM AIR HEATING”
6. NFPA 211 “CHIMNEY, FIREPLACES, VENTS AND SOLID FUEL BURNING APPLIANCES”

The above standards publications are available from:

National Fire Protection Association
Batterymarch Park
Quincy, Massachusetts 02269

4.03 INTRODUCTION (see figure 7 - 10)

Choose a proper location prior to installing your Heatwave furnace. Carefully adhere to the following installation guidelines, as many service and performance complaints are due to improper installation. Some of the recommended guidelines may not seem important, but any deviation may be an illegal building code violation. Field investigation has shown that virtually all furnace problems are directly or indirectly related to varying from manufacturer’s recommendations.

Your HEATWAVE furnace may be installed on the floor, hung from the ceiling, or placed anywhere in between. Floor installation, check with your local building inspector as to the minimum space required from furnace to floor, as this varies from state to state. For floor installation, set the furnace on an 8” non-combustible platform. This provides air circulation under the furnace and makes it easier work on.

4.04 SITE SELECTION REQUIREMENTS

1. Access to 20-amp grounded outlet on a separate circuit for the Models HW150 and HW250 furnaces and 30-amp for the model HW350 furnace.

IMPORTANT! INSTALL A SEPARATE ELECTRICAL DEDICATED LINE.

2. Access to oil storage tank
3. Access to chimney
4. Access to compressed air line
5. Air compressor capable of minimum 2.0 CFM at 20 PSI for the HW150 and HW250

- and 3.0 CFM at 30 PSI for the Model HW350.
6. Clearance for the fuel line to furnace
 7. Adequate circulation of air from furnace through building
 8. Adequate combustion air to burner and furnace

4.05 INSTALLATION OF FURNACE ON A COMBUSTIBLE FLOOR

Normally, the heater should not be installed on a **wood floor without some sort of brick, block or metal shelving to serve as a barrier between the heater and the wood surface.** Local fire authorities should be consulted to help you in conforming to code. Usually the furnace must be set on an elevated, ventilated concrete or fireproof ceramic block not less than 8” high and onto an iron or steel flat pan with the edges turned up to contain any fuel drippings.

4.06 INSTALLATION: CEILING REQUIREMENTS

For ceiling installations, the ceiling must be structurally capable of supporting the weight of the furnace to be hung. Use 5/8” all-thread rod on the straight through hanging design of the cabinet or screw the rods through, using the four brackets on the top of the furnace cabinet to attach to the ceiling supports.

4.07 INSTALLING HEATER TOO HIGH

DO NOT MOUNT THE HEATER ANY HIGHER THAN NECESSARY, as you must service and clean your furnace periodically, and the lower the furnace the safer. Also, to create proper negative draft, you may use the cheaper single-wall chimney connector inside the building. However, code requires that Class “A” insulated chimney connectors be used through your ceiling and outdoors. REMEMBER, if you don’t have enough DRAFT, you must add more chimney, and adding it outside to the building can be costly!

4.08 VENTILATION AND COMBUSTION AIR REQUIRED

Each installation situation is different and requires varying numbers and sizes of outside air openings. Study the groupings listed below and determine which best describes your situation. Remember that in every situation, ventilation air and combustion air must be provided.

4.09 VENTILATION AND COMBUSTION AIR GROUPINGS

- A. Furnace located in a confined space within a building with all air for ventilation and combustion coming from inside the building.
- B. All combustion and ventilation air coming from outdoors (a very airtight structure)

- C. Ventilation air coming from inside the building, combustion air coming from outdoors.

4.10 LOCATION OF FURNACE: CONSIDERING VENTILATION AND COMBUSTION AIR

- A. You must select an installation location that will provide a sufficient amount of air for combustion. Avoid closets, utility, and furnace rooms if you can; however, if the furnace must be installed in a closed room, add fresh air openings to insure that proper combustion air is supplied to the heater. In a building with all air coming from inside the building, the confined space shall be provided with two permanent openings, one near the top of the furnace room and one near the bottom. Each opening will have a free area of not less than one square inch per 1000 BTU per hour (140 square inch) per gallon per hour of the total input rating of all appliances in the enclosure freely communicating with the interior areas having in turn adequate infiltration from the outside.
- B. Should the building be extremely airtight in construction, the doors/windows seldom opened, and furnace is installed into an UNCONFINED space where infiltration of air is not adequate to provide air for combustion and ventilation, the air for combustion and ventilation shall be obtained from the outdoors or from spaces freely communicating with the outdoors. A permanent opening or openings having a total free area of not less than one square inch per 5000 BTU (28 square inch per gallon per hour) of total input rating of all appliances shall be provided under such circumstances.
- C. If you install your furnace in a confined space and all air for combustion and ventilation is obtained from the outside, there must be two openings communicating with the outdoors or by means of vertical ducts; each opening is to have a free area of not less than one square inch per 4000 BTU per hour (35 square inches per gallon) of the total input rating of all appliances in the enclosure.
- D. If horizontal ducts are used, each opening shall have a free area of not less than one square inch per 2000 BTU per hour (70 square inches per gallon per hour) of total input of all appliances in the enclosure.
- E. A furnace in a confined space where adequate ventilation is provided from inside the building and combustion air is obtained from outdoors, the enclosure shall be provided with two openings for ventilation. In addition, there shall be one opening directly communicating with outdoors or to such spaces (crawl or attic) that freely communicated with the outdoors. This opening shall have a free area of not less than one square inch per 5000 BTU per hour (28 inches per gallon per hour) of the total input of all appliances in the enclosure.

4.11 AIR CIRCULATION / HEAT DISTRIBUTION

There are many recommended ways to direct heated air in your buildings. Advice from a qualified heating mechanic is helpful. Generally, heated air is directed toward areas of

maximum heat loss. Some mechanics will implement a circular air movement for comfort. Some time and money spent in proper placement will pay off in comfort and lower costs.

NOTE: HEAT RISES!! Theoretically, if your ceiling is too high, you can never heat the ground area. If your roof or ceiling height is over 14 feet, install industrial ceiling fans to bring this valuable heat down. Installing ceiling fans will not only give you comfort but can give you a twenty percent reduction in energy costs. Do not use anything smaller than a 56" blade fan as smaller, shorter blades will cause the air to tumble resulting in an uncomfortable draft. There are many situations where the furnace is functioning properly, but there is poor heat distribution.

4.12 MINIMUM CLEARANCES FROM COMBUSTIBLES

MINIMUM CLEARANCES FROM COMBUSTIBLES MUST BE MAINTAINED FOR SAFE OPERATION

These clearances are:

MODELS	HW 150	HW250	HW350
BACK	26"	26"	26"
TOP	18"	18"	18"
SIDE	18"	18"	18"

ANY CHIMNEY CONNECTOR: 18" CLEARANCE ON ALL MODELS

Once you have chosen the location for your HEATWAVE furnace, set the furnace into position. On ceiling mounted furnaces, I recommend that the louvered end be pointed downward to reduce air flow resistance. In this way the louvers need not be adjusted so far down, and the circulation air can blow straight out. The burner side of the cabinet should be mounted slightly upwards to increase the tilt of the burner. There is supposed to be a 5° tilt on the burner blast tube of the cabinet, a little more will guarantee no oil drippings onto the floor! If there is oil condensation, it will drip oil into the chamber where it can burn. With the furnace in position, you are ready to install the burner and blower, connect the chimney, and install the oil and compressed air line.

4.13 BLOWER INTALLATION: (You may not have to do the following on furnaces manufactured by Siebring Manufacturing)

1. Fit blower over mounting flange on side of furnace and fasten in place with #10 x ½" Tek screws provided.
2. Mount the blower motor on top of the blower housing.
3. Assemble the pulleys and drive belt between the motor and blower.
4. Run the wires from the blower motor down the conduit on the top front of the furnace junction box.
5. Fasten the flex conduit between the blower motor and EMT conduit.
6. Fasten the round fan guard to the blower side opposite the blower belt and pulleys using #8 x ½" Tek screws provided. Holes for Tek screws are not pre-drilled.

Fasten the belt guard to the pulley side of the blower using #8 x ½” Tek screws provided.

7. The blower installation is complete.

4.14 BURNER INSTALLATION

1. Check the electrode alignment before installing burner into the cabinet. The burner was tested and adjusted before leaving the factory. However, the electrodes may have been knocked out of alignment during shipment. (See figure #13 in the drawing section for proper adjustment)
2. On the burner is the electrical box with hinged lid containing the oil and air pre-heaters and the electrical wire terminal strip. Please check to insure all of the screws are tight and the pre-heater thermostat is set to 150° F. If you are starting the furnace with #1 or #2 furnace fuels, be sure to turn the pre-heater switch OFF! (Center position of the switch to the left of the indicating lights on the burner)
Ensure that the pre-heater switch is ON (all the way up on the three position switch) for burning waste oil. (See figure #6, index of drawings for illustration)
Once the cover is replaced and tightened down, the burner is easily mounted on the cabinet using the three flange nuts provided.
3. Attach the swing-out burner bracket to the burner mounting flange.
4. Remove swing-out bracket from furnace mounted bracket by removing the hinge pin and one ¾ X 16 (9/16” wrench) flange nut.
5. Remove burner mount flange nuts from swing-out bracket.
6. Remove burner from box. Remove plastic wrap and cardboard blast tube protector.
7. Mount swing-out bracket to burner flange by inserting the two ¾ stud ends (welded to the bracket) through the left and right burner flange mount holes. Install two ¾ X 16 flange nuts loosely.
8. Mate swing-out bracket and furnace mounted bracket and install hinge pin. Check for clearance by swinging the assembly, adjust as required to allow the blast tube to clear and tighten the left and right flange nuts.
9. Install burner gasket. If using the cardboard type gasket, burner retention head must be removed prior to installing the gasket. Remove the ¼” drive sheet metal screw to remove retention head. Install gasket and reinstall retention head.
10. Swing assembly closed and secure by installing one ¾ X 16 flange nut on the upper burner mount stud.
11. Connect burner power cord into the socket on the electrical box located below or near the burner. As a safety feature this POWER CORD MUST BE DISCONNECTED BEFORE THE BURNER CAN BE SWUNG OPEN FOR SERVICE!

4.15 CHIMNEY REQUIREMENTS (see figure 7 & 8)

1. The chimney sizes to be used with all HEATWAVE furnaces are 8” diameter. DO NOT USE ANYTHING LESS THAN STANDARD OIL CHIMNEY CONNECTORS, of not less than 24 gauge steel.

2. Single wall may be used inside the building. However, Class A insulated chimney connectors **MUST** be used in exiting the ceiling or roof and the outdoors. NOTE: The furnace may operate using a single wall chimney connector outside on the roof. **HOWEVER, THIS IS DANGEROUS and AGAINST CODE.** The rising hot air is what creates draft and when the cold outdoor air chills the single wall pipe; an air plug is created in your chimney which will cause backfiring and sooting of your electrodes, finally leading to **NO IGNITION!** Your furnace is made to operate on a negative draft, if the combustion chamber should leak, all obnoxious gases will exit out the chimney. You have no doubt, built a fire in a fireplace when the room was cold. Much of the initial smoke blew back due to the absence of a heat-generated draft. Once the chimney was heated, a draft was created and the smokes exited up and out. This same principle is why you must **NOT INSTALL SINGLE-WALL chimney connectors outdoors.** Also, cooling this hot exhaust condenses acid, which will quickly corrode your outdoor chimney. **DO THE INSTALLATION RIGHT THE FIRST TIME!**
3. **DO NOT REDUCE YOUR CHIMNEY SIZE TO LESS THEN 8"!** In fact, whatever the stack collar size is on your furnace, do not reduce it to a smaller size. **THIS IS AGAINST BUILDING CODES IN MOST STATES.** It may be tempting to install your HEATWAVE furnace into a 7" or smaller existing chimney but **THIS IS AGAINST CODE AND SERIOUS AND DANGEROUS PROBLEMS WILL BE CREATED. DON'T DO IT!!**
4. The chimney will be at least 3' above the point where it passes through the roof and 3' higher than any obstruction within 10', such as another building, false fronts and roof peaks. (Refer to HEATWAVE'S drawing illustrating the furnace installation) (See Drawing Index figures 7 - 9)
5. No chimney shall pass through or be within 2" of combustible material, unless it is guarded at the point of passage with a non-combustible collar. Observe the manufacturers minimum clearances on products such as insulated collars and triple-wall connectors.
6. Install proper recommended roof jacks (Insulated pipe supports), rain collars, and proper sealant to insure against water leaks.
7. Install a "T" on the chimney coming from the furnace instead of a curved 45° chimney connector. So, if water should leak from above, it will not carry to the hot combustion chamber. Let the water drop from the "T". (See index of drawings, figures 7 - 9 for illustration)
8. The chimney must have a nonrestrictive type cap on the outside approved for oil burning equipment.
9. The chimney shall be capable of producing a -.02 W.C. when cold. (Refer to manometer or draft gauge in index)

4.16 CERAMIC OR MASONRY CHIMNEY

I do not recommend using an existing masonry chimney. You can avoid making an excessive horizontal run by simply going straight up. Remember, you want to get the hot corrosive exhaust up and out.

Many ceramic chimneys are carboned, sooted, or coked up, restricting proper draft. Although the outside diameter on many may seem adequate, the inside liner, sometimes made of clay, is extremely small. You cannot connect your 8" HEATWAVE stack into a 5" square chimney and still retain a good unrestricted flow. Existing ceramic chimneys may be too small and restrictive or TOO LARGE. Avoid using chimneys that run from the ground up and are constructed on the outside of the building. **IF YOU DON'T WANT TROUBLE, AVOID USING THIS TYPE OF CHIMNEY.** Remember rising hot air is what causes the necessary draft; these chimneys are cold and will create an "air plug". To correct many field installations with outside chimneys, it is necessary to put an insulated metal chimney inside the large cold chimney or to incorporate a power DRAFT BOOSTER. If a masonry chimney must be used, adhere to the following guidelines:

1. Use a masonry chimney that is constructed on the **INSIDE** of the building, not an external **COLD CHIMNEY**.
2. Be sure the passageway of the chimney is at least 8" in diameter, and does not exceed 12".
3. The masonry chimney must have a non-restrictive cap designed for oil burning equipment.
4. The masonry chimney must be capable of producing a negative draft of -.02 W.C. when **COLD**.
5. Do not use a chimney that has an opening below the exhaust entry of your waste oil furnace, such as a fireplace. You must block such openings with ceramic fireproof material at least 12" below the HEATWAVE exhaust entry pipe. Avoid using a masonry chimney where other appliances are connected to the same chimney.

4.17 CHIMNEY CONNECTOR

This is the pipe that connects your heater to the chimney. This pipe must be approved for oil burning equipment, be 8" in diameter and not less than 24 gauge steel. The following should also be considered:

- A. Use a "T" at the base of the chimney with a removable cap at the bottom. This cap will allow access to the dust for cleaning and keep condensation from the inside and water leaks from the roof entering the hot combustion chamber. The chimney connector attaches to the side of this "T" (see Index of Drawings #7 - 9 for illustration).
- B. When installing the connector, avoid sharp turns and bends and any features which will create resistance to the natural draft flow. Many uniformed installers will purposely use long runs of single-wall inside a room to radiate heat, trying to reduce the stack temperature and make the furnace more efficient. This is against code and your heater will malfunction due to poor draft. Cooling the draft this way will also condense the acidic exhaust which will eat up your connectors. Avoid exceeding 10 feet horizontal run, in some states this length is restricted to not more than 12 feet. Other states have a formula of vertical chimney to

- horizontal length such as 30% to 70%. Remember, where you can, avoid horizontal lengths of chimney connectors.
- C. By code, the chimney connector must rise at least ¼” per foot. **THIS MUST BE TREATED AS A MINIMUM.** The greater the pitch will help the natural draft flow. Therefore, try to get the connector as vertical as possible.
 - D. The chimney connector must be at least 18” away from all combustibile material. **THIS IS A CODE REQUIREMENT.**
 - E. **DO NOT** pass the connector through any unheated areas such as false ceilings, attics, storage rooms, etc. Class A insulated pipe must be used in these situations. These areas will cool chimney connector and exhaust gases, killing the natural draft. Again, the rising hot gases create necessary draft.
 - F. **DO NOT** install any device such as heat reclaimers, manual draft controls, or anything that will obstruct the free flow of flue gases into the chimney or connector.
 - G. Chimney connectors should be held with a minimum of three screws or rivets at each connection, with not more than two elbows or 45° chimney fittings; and should be installed as close as possible to the chimney. Both the chimney and connectors should be kept in good condition. All joints, clean out access doors, and any leaks must be sealed.

4.18 CHIMNEY CLEARANCE OUTDOORS

Keep the outdoor chimney clear of all obstructions, such as other buildings, roof peaks, or false fronts. The chimney should be three feet higher than any other obstruction within 10 feet. See drawing on installation figure 7 - 9 and further information under “Chimney Installation”.

4.19 SPECIAL CHIMNEY CAPS FOR DOWNDRAFTS

Furnaces located in an especially windy area or situated below a hill where winds have a tendency to blow down chimneys causing erratic flame fluctuations can be corrected by using special turbine caps or sail caps that turn away from the wind. Your local furnace supply store should have them available. KHS stocks these sail cap.

4.20 BAROMETRIC DAMPER/BAROMETRIC DRAFT CONTROL

The barometric draft control cuts or decreases the draft automatically to prevent the draft in the combustion chamber from exceeding an established level. By code, the barometric damper **MUST** be installed on your furnace.

THE BAROMETRIC DAMPER MUST BE AN APPROVED TYPE FOR OIL BURNING EQUIPMENT. DO NOT USE ONE DESIGNED FOR WOOD STOVES.

It should be installed close to the furnace, preferable in; the first section of the flue pipe. The opening in the pipe should be the full size of the collar of the draft control. The hinge should be level and swing freely. The barometric damper should be facing away

from the draft created by the movement of air from the circulation blower. On furnaces mounted close to a wall, the circulation blower draws quite a large volume of air; thus, it could cause the damper to malfunction. Use a spirit level to ensure that the control does not lean forward or backward and is level

Follow the manufacturer's advice (supplied with the damper) on the assembly of your barometric damper, as the weights (such as the balancing weights) and parts on most barometric dampers must be first assembled before they are installed in the pipe.

Proper operation of your furnace and your barometric damper depends upon proper installation and adjustment.

4.21 OIL TANK INSTALLATION / PUMP / PIPING SECTION

CAUTION: You must adhere to NFPA (National Fire Protection Association)

No. 30 – “Flammable and Combustible Liquids” and NFPA

No. 31 – “Installation of Oil Burning Equipment” and all federal, state and local codes.

Be careful, especially about buried tanks, as federal rulings may change and they would override any state and local rulings.

4.22 FURNACE AND STORAGE TANK CLEARANCE

To ease installation and keep costs down on piping fuel, install your fuel tank inside your building where it will stay warm and as close to the furnace as possible; however, **NO CLOSER THAN SEVEN FEET**. Since all pumps push fuel better than they suck fuel, it is **VERY IMPORTANT** to mount your fuel pump as close to and as low to your supply tank as possible. Waste oil can be very thick when cold so do not expect **ANY** pump to suck thick waste oil higher than 12 feet vertically. Keeping waste oil in a warm ambient makes colloidal water and sludge separate out faster. Observe recommended pipe ID sizing in the vacuum and pressure side of the fuel system.

4.23 TANK SIZE SELECTION

It is best to use as large a tank as possible and to place it in an environment where the ambient temperature doesn't drop below 35° F. Waste oil can have as much as 20% contaminants and undesirables such as water and sludge, which will separate to the bottom of the tank when the oil is kept, warm and thin. We do not recommend using a 50 gallon drum as a storage tank as it is too small a container; as owners frequently run out of oil at night and mechanics are pouring waste oil into the drum, constantly stirring up the contaminants, which can cause frequent filter clogging. Waste oil sitting seems to clean itself. You have no doubt checked the oil in your car after it has stood for awhile and noticed how clear it was; then, shortly after starting your car, it turned black. Take advantage of this property of waste oil. You may not be able to use as large a storage tank as you desire. If you have a basement in your building, you may by code be restricted to 60 gallons as a storage minimum. Check with your local fire marshal as to what size tank you can use, as in many areas, regardless of code regulations, you will not

be able to store more than 60 gallons of waste oil. Without a basement, generally you may be able to use two unenclosed tanks for a total aggregate of 660 gallons.

For safety, be sure each tank can be turned off with a ball valve. Use a straight-through type valve, as other designs would be hard to clean. You may be asked by the fire inspector to install an automatic fire shut-off valve or an anti-siphon valve on these tanks. Be sure that the supply tank inside has at least a 2° pitch with a drain valve at the lowest end to remove water and sludge. On large tall storage tanks, especially where the tank is installed on a high elevated location, the head pressure to the pump must not exceed 3 PSI to the pump. This is an OSHA regulation. Call KHS for info to correct this problem.

4.24 OIL TANK TEMPERATURES

THERE IS NO PUMP THAT WILL PUMP A SOLID. Waste oil becomes extremely thick when it is cold, and will turn virtually into a solid in extreme cold. Do not install your storage tank outside where low temperatures will chill the oil. If you must locate it outside, you will have to bury it below the frost line or install an approved immersion oil heater. It will also be necessary to **INSULATE THE TRANSFER PIPES AND WRAP THEM WITH HEAT TAPE.**

4.25 UNDERGROUND TANKS (USE OF)

You may pipe waste oil directly from a buried outside tank to your heater. However, be sure your piping is buried below the frost line. If the piping is above ground and exposed to the cold ambient, these pipes must be wrapped and insulated with heat tape. Be sure that the pump is located inside the building where it is warm and as low as possible to the ground.

If you bury your waste oil transfer pump, or it is below ground level or near a storage tank, by code, the pump must be explosion-proof in design. Try to avoid this situation as code requirements may make it costly to install. If you are using an old buried underground tank, I find most of these old tanks are extremely dirty. Be sure that it is clean and free of leaves, floating debris, and water. Many waste oil collectors will pump away your oil, but leave the sludge and water behind, as it is a liability and a burden to dispose. Carefully pump and properly dispose of any water, anti-freeze mixtures, etc., before using your underground tank. (See figure #10 for designing a floating sump to be used in dirty tanks).

4.26 VENT PIPE FOR THE STORAGE TANKS

USE THREAD SEALING COMPOUND ON ALL PIPE CONNECTORS; BE SURE TO FLUSH ALL LINES BEFORE START-UP. (See section on Pump Priming)

Install a vent pipe to your storage tank using 1-1/4" diameter or a size equal to the fill pipe. Do not use vent pipe less than 3/4" diameter. Your vent pipe **MUST BE AS LARGE OR LARGER THAN YOUR FILL PIPE.** The vent pipe must extend outside the

building and at least two feet from any building openings. The vent pipe must not cross-connect with any other pipes and not extend into the supply tank more than one inch. Install a weatherproof breather cap onto the end of the vent pipe so water and any debris can be kept out.

4.27 FILL PIPE

Install a fill pipe using black NPT iron, not exceeding the diameter of the vent pipe. This fill pipe must extend to the outside of the building and at least two feet from any building openings. The fill pipe should connect to the storage tank and not extend into it more than one inch. Install a weatherproof cap onto the fill pipe.

4.28 TANK VENTING / FILLING / GAUGE

The inside tank must be vented outside with a pipe not less than 3/4" ID. It may be larger, depending on the fill pipe diameter. Since waste oil can contain gasoline, these vapors must be vented to the outdoors. There should be a gauging device to determine the amount of fuel inside the tank and all parts of the storage tank must be sealed. Generally, the fill pipe is placed through a wall and capped. Many waste oil furnaces including the HEATWAVE furnaces are sold and installed onto a workbench tank with the furnace on top and the storage tank beneath the heater. Code allows this type of installation, provided the heater is at least five to seven feet above the tank; however, HEATWAVE does not recommend this system unless all the building codes are adhered to and maintained as such. Tanks must have a fuel gauging device, a fill pipe separated by a wall and capped and the tank sealed shut.

Always strain the waste oil before pouring it into the main storage tank, as it would be impossible to clean the storage tank otherwise. It is recommended to let the waste oil flow over a bar magnet to pick up any, metallic sludge, which will cause your magnetic solenoids in the waste oil burner to stick and malfunction.

4.29 TANK AGITATOR (For mixing different viscosity oils)

If you run out of waste oil and fill your tank with lighter viscosity fuels such as #1 and #2 furnace fuels, for efficient combustion, the pressure adjustment on the oil regulator should be checked. If the storage tank capacity is small such as a 55-gallon drum many owners use, frequent adjustments may be necessary as a smaller volume of fuel changes the total viscosity. A 55-gallon drum is not recommended for a storage tank. A tank of at least 250-gallon capacity is recommended. There are commercial agitators approved for tank use. Using copper tubing and blowing compressed air into the bottom of the tank can make an inexpensive, safe agitator. The rising air bubbles and the force from the compressed air will cause currents inside the tank to agitate and quickly mix the different viscosity oils to a single homogeneous mixture.

4.30 FLOATING PICKUP OIL SUMP (For dirty underground tanks, figure #10)

If you suspect your buried tank of being contaminated, it would be wise to use a floating pickup sump. This simple device floats up and down with the oil level in the tank and takes the oil from near the surface where it is cleaner. Water, sludge, and anti-freeze tend to be heavier and collect near the bottom of the tank. If a floating sump is not available commercially, it is simple to make one. Take a single-wall, thin, flexible, gasoline-proof, synthetic rubber hose and cut a length of it so that when perpendicular with the check valve and suction strainer on the end, it will be one foot off the bottom of the tank. Wrap or connect a buoyant material, such as a small, slender, round butane tank, after it has been soldered shut and clamp it to the hose. It must not be able to move up and down. Be sure that the materials are corrosion and gasoline-proof. A float made out of stainless steel such as ones used in automotive gasoline tanks can be screwed onto the end of the suction strainer. Weigh the check valve and suction strainer that you are using and calculate by weight volume the amount of oil it must displace to be buoyant. Remember that waste oil, as thick as it is, is lighter than water. A specific gravity of .78 at room temperature could be used for your calculation. The float will not be very large. After construction, simply check it with a container of #2 furnace oil. The orifice of the floating sump when correctly made should be slightly lower than the level of the oil. Do not worry that the thin, single-wall hose will collapse, as the oil flow to the burner is extremely slow. It would be less than four gallons per hour. (See Index of Drawings for illustration (Figure #10).

4.31 PUMP INSTALLATION AND GENERAL PUMP INFORMATION

Mount the pump as close to the oil supply as possible and as low as possible, as all pumps push well, but lack strong suction.

DO NOT MOUNT THE PUMP OUTDOORS IN AN UNHEATED STRUCTURE. The Heatwave pump and most electric gear-driven pumps are **INDOOR PUMPS**. The **HEATWAVE**-furnished pump is not explosion-proof. You will need an explosion-proof electric pump motor if you are going to mount your pump below ground such as next to an underground buried tank. Check with building code authorities to obviate any serious hazards you may create installing buried tanks or pumps. Your pump from Heatwave is optional and if you prefer a different model or make, Kagi Heating Supplies & Manufacturing, Inc. probably has it available.

MOUNT YOUR PUMP HORIZONTALLY as specified by the manufacture for best performance and safety. Some pumps will not bleed well in a vertical position. **DO NOT MOUNT YOUR PUMP VERTICALLY** with the pump head up; should the pump shaft seal leak, oil could drip into the electric motor.

DO NOT MOUNT YOUR PUMP SO ACCESSIBILITY FOR SERVICE IS RESTRICTED. Most pumps have a filter or screen built inside that must be cleaned periodically.

Install a pressure and vacuum gauge directly into your pump. These gauges are not expensive and are available from Kagi Heating Supplies & Manufacturing, Inc., 1-888-

866-5244 (toll free) usually less than \$25.00 each, and will help keep service maintenance down. These gauges will also help diagnose problems in the fuel system. Install a shut-off petcock on your vacuum gauge, as constant vacuum on any vacuum gauge will ruin it. Merely turn it on when a reading is desired and then shut it off again.

When you know that the filters, pump screens, and suction strainers are clean, as on a new installation, this will be your lowest vacuum reading; mark your vacuum gauge with permanent ink. This will be your “zero” starting point. In use, be sure the reading does not exceed “20” of Hg. When the vacuum rises at least four inches or more from the established “zero” point, it is time to clean your filters or strainers. As the oil chills and thickens or different viscosity oils are added to your storage tank, you will know by the vacuum gauge reading why it has a higher reading. A pump failure, malfunction, or vacuum leak will be discovered very quickly with the vacuum gauge.

Do not exceed the limitations stated by your pump manufacturer, as exceeding these limits will cause malfunctions and shorten the pump life. Installing the pump, differently as shown in this manual, may cause damage to your pump, and thus void all warranties.

The fittings on your pump may be smaller than ½” or ¾” diameter. Which are sizes of piping used to transfer the oil. You may reduce these sizes at the pump. The larger sizes used in piping are to overcome flow resistance. Observe the rotations of the motor driving the pump. If you are furnishing your own pump and motor, ascertain the rotation of the pump, as it won’t work if it’s turning backward. The arrow on some pumps may be the rotation needed for the pump and not the flow direction.

4.32 OPTIMUM PUMP LOCATION

All pumps push fluids well, but do not have good suction. The push of a pump is directly related to the internal bypass pressure, which is regulated and adjusted. An adjustment screw can increase this pressure, which is on most transfer pumps. The suction unfortunately cannot be increased over the weight of the atmosphere, and this depends on altitude and geological location. The oil is pushed on the suction side (even with a perfect vacuum) by atmospheric pressure, which is only 14.7 lbs. per square inch at sea level. Therefore, we are limited by the resistance on the suction side created by length and distance up, along with natural flow resistance and high-viscosity fluids. With this information in mind, try to locate and use the best situation for the pump; this is to place the transfer pump as close to the oil supply as possible and as low as possible to avoid any lift.

4.33 FUEL FILTER AND LOCATION (see figure 24)

Depending on the manufacturer’s recommendations, a filter or filters are to be installed on the suction side and sometimes on the pressure side. In general, most manufacturers of waste oil burners want the filters installed on the suction side of the piping. Combu and Sunfire suggest two filters, a 100-micron filter and a 300-micron filter on the suction side. Suntec and Delta pumps require only one, a 100 micron-filter (see figure 24).

Many installers avoid installing filters on the suction side due to problems arising from minute air leaks coming from thread connections, poor sealing on the oil filters, time lost in priming the oil filter etc. On the other hand, filters mounted on the pressure side are prone to pressure leaks, which should worry many owners. Many of the oil filters on the market especially ones sealed with a rubber “o” ring are not U.L. engineered to withstand pressures over 35 PSI. A malfunctioning by-pass on a pump could shoot the pressure over 350 PSI! **NOTE: The rubber o-ring seal designed filters furnished by furnace vendors are designed for pressure under 40 PSI! Install filters according to the manufacturer’s instructions.**

HEATWAVE OIL FILTERS ARE TO BE INSTALLED ONLY ON THE SUCTION SIDE OF THE FUEL DELIVERY SYSTEM. (See drawing illustration Figure #10 & 30 in the back of the owner’s manual. Also, carefully read section 8.40 on Oil Pressure Climbing, due to Cold Oil Expanding).

DO NOT INSTALL A SHUT-OFF GATE VALVE ON THE PRESSURE LINE TO PREVENT OIL FROM COMING BACK FOR SERVICING THE FILTERS. Use a check valve instead. If a gate valve is accidentally left closed, serious high pressure could develop.

4.34 PIPING AND FUEL LINES

See Index of Drawings for piping and tank installation guidelines. The maximum suction lift and maximum line lengths specified for different viscosity oils are based on a suction vacuum of 29 inches (at sea level) of Hg at the pump. For best results, the lift and length should be as short as possible to minimize suction vacuum. Operating suction vacuum should never exceed 20” of Hg. Dirty restricted oil strainers or filters will raise your vacuum. Operating your pump with vacuum in excess of 20” Hg will vaporize volatile fluids in your oil and cause air locks and pumping failure.

The standpipe inlet that supplies the fuel must be at least 12” off the bottom of the tank to prevent water and sludge from clogging the filters and strainer permanently. It is very important that the suction piping is AIRTIGHT. Whenever air enters the suction line for any reason, any air leaks, however slight, will interfere with pump and furnace operation. Always top up the lines and filters with filtered oil before starting the pump.

DO NOT RUN THE PUMP DRY FOR EXTENDED PERIODS. Be sure to install a check valve or foot valve to prevent the fuel from running back into the tank. Check with local authorities to determine if you can install a check valve inside your tank. If this is forbidden in your area, install a check valve at the lowest, most convenient point.

A “T” should be installed at the highest point in the suction line with a removable cap to fill lines, filters, and the pump for priming. This vent pipe is necessary for the expansion of the fuel by heat. Remember, liquids cannot be compressed; however, trapped air can be.

DO NOT USE TEFLON TAPE. Many pump manufacturers forbid its use and will void the warranty if this tape is found in their pumps. “Pipe Dope” or Teflon liquid cement or any other thread sealant is permissible. Avoid using connectors, reducers, etc. Keep connections to a minimum to avoid air leaks. Removable steel unions although tight, are always a source of leaks. They are designed for pressure, not vacuum. Use flare fittings, not compression fittings on the suction side. **CAUTION: DO NOT USE STEEL UNIONS as they will leak under vacuum!** Pressure check the suction side for leaks with liquid soap.

NO AIR SHOULD SPURT OUT OF THE FUEL PUMP BLEEDER VALVE! IF IT DOES YOU MUST CORRECT and ELIMINATE THIS SMALL VACUUM LEAK. Failure to stop a small vacuum leak will cause air to accumulate in the suction side; a column of air will parade up to the burner and a SHUTDOWN WILL OCCUR!

4.35 PIPE DIAMETER

Hagen-Poiseville’s law teaches that liquids have frictional flow resistance. Therefore, in horizontal runs we must consider the inside diameter of the transfer pipe to lower the flow resistance. Observe the guidelines on pipe diameters given in this manual. Do not attempt to operate this furnace with too small a diameter pipe. On the other hand, too large a pipe especially on the suction side would be prone to leaks (due to large and coarse threads) and hard to bleed using a small displacement pump. Using too small a pipe may be a CODE VIOLATION! Use of too small a pipe will result in noises, overheating of the transfer pump and other undesirable problems.

Generally, on the **pressure side** if the ambient temperature is above 40° F., 3/8” inside diameter copper tubing can be used up to 30 feet, and in lengths of 30 to 70 feet use 1/2” inside diameter piping. For lengths up to 200 feet, on the suction side of the piping, use 3/4” inside diameter piping. If the ambient temperature is going to be low, use minimum of 1/2” inside diameter on the pressure side and 3/4” inside diameter pipe on the suction side. If the suction, the pump, or delivery pipes are exposed to freezing temperatures, use heat tape.

4.36 PIPE MATERIAL

DO NOT use rubber, plastic, fire-resistant rubber hose, or galvanized iron pipe. Use only copper, brass, or black iron pipe. This is the LAW. In case of fire of outside origin, plastic pipe or any heat-sensitive material will only feed the fire. If you are using copper tubing, use flare joints and **DO NOT USE SLEEVES and COMPRESSION NUTS.** Solder is permissible but you must use solder that has a melting point in excess of 1100° F.

4.37 COMPRESSED AIR SUPPLY

Compressed air for the KAGI burner is needed to suck out and atomize the heavier viscosity oils, using a special low-pressure fuel delivery nozzle. The KAGI burner does

not use a large amount of air and only needs a compressor capable of delivering 2.0 cubic feet of air at approximately 20 PSI for the models HW150 and HW250 and 3.0 CFM at 30 PSI on the model HW350. This is referred to as the PRIMARY AIR or air for atomization. Set the air pressure at 12 PSI or above for waste oil.

NOTE: Exceeding the recommended air pressures will NOT necessarily increase the burning rate. To increase the burning rate, a different larger gallon per hour (GPH) nozzle must be used. DO NOT INSTALL A LARGER NOZZLE in your KAGI heater, as over-firing your furnace will VOID your warranty and could create a hazardous situation. You may, however, use a smaller size nozzle to burn lighter viscosity fuels. Call the KAGI Service Center for your particular problems regarding fuel viscosity and your nozzle size. Excessive air, whether from the primary or secondary, will chase more heat up your stack instead of into your room. Your CO₂ readings will be lower, indicating a lower thermo-efficient burning furnace.

NOTE: Be sure to call the KAGI Service Center for proper installation of your remote air compressor. WARNING: Do not connect and overload the primary with the air compressor. You must install a 24 volt / 110 volt switching relay.

WATER IN THE LINES: If your air supply contains high moisture content or water, your furnace will not ignite. It is hard to detect moisture vapor coming out of the nozzle as the spray is still very black. Do not connect the airline from the ceiling down to the burner, as condensation in the pipes will collect by gravity and enter the air regulator. Instead, bring the air supply lines up to the burner so any condensate will stay at a lower level. Install a moisture and water trap at the lowest location to keep your air lines dry.

CAUTION: Do not use air coming from an inline automatic oiler to your KAGI burner. Your furnace will malfunction and coking of the electrodes and other problems will arise. Automatic air oilers are for AIR TOOLS and NOT for waste oil furnaces. .

4.38 COMPRESSED AIR PIPING

Use ¼" NPT black iron or 3/8" copper tubing for piping the compressed air supply. Install a shutoff valve at the compressor and at a location near your furnace for quick disconnect of your air service if it is required. A quick disconnect union at the regulator makes it easier yet. (The KAGI burner has quick disconnect couplers for the oil and air!) A tee with a short drip leg and a valve for blowing out any condensation should be installed. If the shop air pressure is high (some are set at over 200 lbs. PSI), install a primary air regulator with a built-in water trap. The KAGI air regulator is tested at 150 PSI; however, it should not be operated with such high pressures. The primary regulator should be set at approximately 30 PSI during operation and this will stop shop air pressure fluctuations that will affect the burner.

Always remember to plumb uphill to your burner, as this will keep condensation from entering your burner, which causes frequent shutdowns.

4.39 NO COMPRESSED AIR AVAILABLE

If compressed air is not available or the source of air is too far away, we suggest purchasing a small air compressor to use at the site. If a separate compressor is used, do not use electrical current from KAGI'S primary control, as it will overload this circuitry. Please call KAGI for technical assistance and parts needed for the proper installation of your remote compressor.

NOTE: IF YOU HAVE A COMPRESSOR, DO NOT USE A REMOTE COMPRESSOR UNLESS it is for economic reasons. Extra large compressors with high horsepower motors consume a high amount of energy on start-ups.

There is a popular belief that should a piston-type air compressor lose air pressure at night by i.e. bursting a hose or line in the shop, after it loses all its pressure, the air compressor will burn up. This is not true. Compressors with no static pressure will merely "free wheel" happily all night. It is heat that is damaging to a piston-type compressor, by overloading its capacity. If the compressor failed, it was due to fail regardless. We recommend that if you do not wish to leave the compressor on at night for fear of a rubber hose breaking, etc., install a shutoff ball valve at the compressor to the shop and leave the compressor on. Connect a small copper airline from the compressor tank to your Heatwave furnace for night operations. KAGI does not recommend leaving your heater on at night with the compressor off. Should the small diameter copper line break or leak, your compressor should be able to handle the air loss.

4.40 ELECTRICAL SUPPLY (see figures 26 & 27)

NOTE: ALL WIRING SHALL BE DONE IN ACCORDANCE WITH THE NATIONAL ELECTRICAL CODE, NFPA NO. 70 and state and local ordinances for equipment installed in the United States.

The HEATWAVE furnaces Model HW150 and HW250 shall be on its own individual electrical circuit (dedicated line) fused at 25 Amps and the HW350 at 30 Amps, 120 Volts AC, 60 Hz.

Adjacent to your heater or as close as convenient, install manual service disconnect. All line power in will be connected and enclosed within the junction box.

MAIN POWER CONNECTIONS:

BLACK (Hot, L1)

WHITE (Neutral, L2)

GREEN (Cabinet Ground)

Auxiliary equipment such as power vents or auxiliary transfer pumps of no greater than 1/8 HP may be added to the primary electrical load. **A GROUND CONNECTION MUST BE PROPERLY ADDED TO THE FURNACE TO AVOID ELECTRICAL SHOCKS.**

4.41 ELECTRICAL CONDUIT

The electrical conductors for the waste oil pump and power supply must be of rigid conduit, a minimum of 12 AWG and include an equipment ground.

4.42 ELECTRICAL SUPPLY PUMP

110 Volt AC, two wires from motor:

HOT-----BLACK

COMMON-----WHITE

4.43 PUMP CONNECTIONS FROM WIRING SCHEMATIC (figure 26):

GREEN-----GROUND

WHITE-----NEUTRAL

YELLOW (from junction box) -----HOT

4.44 ELECTRICAL WALL THERMOSTAT

Locate and install a low voltage (24V) wall thermostat away from draft so that it will record true room temperature. Select a model that has an “OFF” or “OPEN” position, if you generally turn the power off to your heater during the night or on weekends. If the ambient temperature is below the thermostat setting, your furnace will try to start when power is turned on to your heater. On almost all-waste oil furnaces, after the power is turned on to the furnace the preheater must warm the waste oil before ignition. If your thermostat has a minimum of 40° F., simply cut on of the wires and install a toggle switch so an open circuit can be established. This will ensure that the furnace can be delayed in firing until the waste oil is up to temperature. Attempting to start the furnace when the oil is too cold will cause smoking, rumbling, and flooding of your furnace. **DO NOT TURN THE CURRENT** to your furnace off, such as on weekends. Constantly turning the current off and on to your burner will shorten the longevity of your air heater. Leave the current on to your burner during the heating season and off during long periods of non-use such as summer time.

NOTE: Most states do not require that the low voltage wiring of the wall thermostat or boiler aqua-stat is in a conduit pipe.

4.45 DUCTED INSTALLATIONS

Opposite the squirrel cage blower is an opening with louvers. These louvers can be removed so a plenum may attach to direct heat to various parts of the building. The HEATWAVE furnace is not designed with a cold air return duct; therefore, the furnace should be located so as to allow cool room air to circulate through the furnace. Ducting

must comply with state and local ordinances pertaining to attachments and clearances stated in the National Fire Protection Association Ruling #89-M.

General guidelines dictate at least 6 inches of clearance between combustibles and the first six feet of duct. Provide at least 2 inches thereafter. If ducting through a wall, provide adequate opening in the wall for return air.

Avoid putting the HEATWAVE furnace into the coldest room such as the shop where smoke and other pollutants will be ducted to the office area. Instead, locate the furnace in the warmer office area and duct the hot air to the shop. Warm clean "take off" air can be taken close to the heater and uninsulated duct can be used.

Ducting the air from a cold ambient temperature will require use of insulating materials on the ducting system.

The ducting system should be designed in such a way so that the same cubic inches of output vent is always available.

DO NOT INSTALL AN AIR FILTER or anything that would restrict the cold air return flow! The HEATWAVE furnace has been designed to operate without an air filter. Impeding the cooling airflow across the heat exchanger will cause the Hi-Limit switch to kick the burner off.

4.46 DUCTING PRESSURES AND CHANGES

(The ducting pressure is -.33 inches W.C. for calculations)

For higher static pressure requirements, the blower speed can be set higher. Increasing the blower speed will put higher demand on the blower motor and cause overheating. You may change pulley sizes; however, do not overload your present blower motor to where it is overheating. If more H.P. is to be used, a switching relay might be needed. DO NOT OVERLOAD THE FURNACE ELECTRICAL CIRCUITRY. Consult a licensed electrician to make this change and a person specializing in ducting calculations.

4.47 LOUVERS (Non-ducted Installation)

On non-ducted installation, do not remove the louvers on the front of the furnace as these louvers can direct the heated air up and down. The louvers will provide some static pressure and load the cabinet casing slightly, and result in better heat transfer from the chamber to the air jacket. Do not put anything in the air blast stream that would impede the airflow. **YOUR FURNACE WILL OVERHEAT IN A SHORT TIME IF THE AIRFLOW IS BLOCKED.**

4.48 COMMENT ON INSTALLATION DRAWING (SEE INDEX DRAWINGS)

The floor mount and ceiling hung installations are similar; however, waste oil furnaces are different in design and performance than standard oil furnaces and the advice given in

this manual should be followed for safety and proper performance. Although code recommends ¼” rise per foot as illustrated in the drawing for chimney connectors, it is best for your chimney installation to be as perpendicular as possible. The reason is that the exhaust flue can be cooler than 400° F. and any condensation will CREATE SULFURIC ACIDS which will corrode the chimney connectors. It is best, where expense is secondary, to install stainless double-wall chimney connectors inside the buildings. In situations where the heater is installed near the ceiling, use as much insulated pipe inside the building as you can. It will guarantee more draft that is so badly needed. Most ceiling-hung installations, I have observed, have inadequate chimney connectors, resulting in insufficient draft. Extending the outside chimney requires the use of insulated stainless steel pipe connectors for outdoors and the extra expense of labor for installing additional items such as guide wire supports.

4.49 COMMENT IN INSTALLATION WIRING DIAGRAM (SEE INDEX OF DRAWINGS)

Be sure that a dedicated line is connected to your furnace! It is against building code to connect your furnace using extension cords or a nearby plug-in. If you don't use a clean dedicated line, you will experience poor ignition, flooded furnace, transformer failures and a host of other problems that may be hard to diagnose. Under certain circumstances, it may be difficult to adhere to these drawings for an exact “just so” installations, as there may be a beam or other obstruction in the way. Where installations cannot be done as illustrated in the drawing, look under specific headings, such as “Chimneys”. Don't forget KAGI'S Service Information Center, if you cannot find the appropriate information.

4.50 SUMMARY OF INSTALLATION INSTRUCTION

All installations must be done and certified by licensed electrical and heating technicians.

1. First, determine the proper location for your HEATWAVE furnace, keeping in mind accessibility for service to the furnace cabinet and burner and ambient temperatures that would affect the ducting of heat and the materials used. Make sure that no combustible materials are nearby, and that ventilation and combustion air to the furnace are adequate, and in accordance with code.
2. The ceiling-hung furnace must be as low as possible. The support rods must be the size designated for that model furnace. Do not use rope, chain, or anything that will allow the furnace to swing or not be secure. The furnace must be hung from ceiling beams, with supports adequate by code to safely carry the weight of the furnace.
3. The chimney connectors to the furnace must be installed as vertically as possible to exhaust the emissions, with a minimum of length and turns, to reduce the natural draft flow. The chimney design must be long in vertical length to produce a minimum of negative .02 inches W.C. of draft when cold and .04 to .06 inches of W.C., operating hot.

4. Any outdoor chimney must be Class “A” insulated pipe with proper roof jackets, rain collars and an unrestricted approved cap for oil furnaces.
5. The furnace must have a barometric damper approved for oil burners, installed in the proper place of the chimney.
6. The furnace must have a single dedicated electrical line from the electrical panel, properly grounded for shocks, conducted and installed by code. The furnace must have a main power shut-off switch besides that on the electrical panel; this switch should be near the furnace, accessible, and clearly marked. HEATWAVE furnaces have this breaker on the furnace cabinet.
7. A wall thermostat with an “off” or “open” position must be used; it must be located properly and away from draft.
8. The oil storage tank must be a code-approved type for waste oil and of the proper size, not to exceed what is permissible by local authorities. The tank must be located where the ambient temperature does not fall below 35° F. Approved methods to keep this oil warm should be implemented if the oil temperature drops below 35° F. The tank should be as close to the furnace as possible, but not closer than seven feet. The storage tank must have a 5° tilt to drain accumulated water, with a straight-through ball valve that can be cleaned. A check valve must be installed at the lowest point of the piping to keep the oil pump from losing its “prime” and the feed pipe in the tank must be sufficiently above the bottom of the tank to avoid picking up any water and sludge.
9. The oil transfer pump must be installed indoors, as close and low to the oil storage tank as possible, not exceeding 17 inches of Hg., operating, and in as warm an environment as possible, never below freezing temperatures.
10. Piping used for transferring the waste oil must be made of iron, brass, copper, or steel, NOT plastic, rubber, fire-resistant rubber hoses, or galvanized steel. The piping must be of proper size without any leaks in the suction side. If solder is used on copper piping, it must have a melting point of over 100° F. Flared fittings instead of compression nuts and ferrules should be used on copper piping.
11. Air lines to feed compressed air to the furnace must run uphill to the burner, so condensed water which forms in the piping will not run down into the burner. There must be traps to collect and drain off any water in the lower sections of the pipe, and if water is a problem with the shop air, a water pre-filter trap should be installed.

5.00 START UP PROCEDURE

1. Set the wall thermostat to “open” or lower than ambient room temperature. Make sure that the power at the main breaker is OFF to the heater.
2. Make sure the supply tank is filled with the recommended fuel and the filters, lines, and transfer pump are filled with filtered waste oil or #2 furnace fuel and primed.

5.01 PUMP PRIMING (see figures 18 - 22)

DO NOT RUN YOUR PUMP DRY FOR EXTENDED PERIODS as you may seize the shaft within the pump. The pump comes pre-lubricated and filled with oil; however, you must PRIME THE PUMP AND LINES. Most gear pumps are not self priming.

Remove the cap on the “T” which is on the suction side of the pump at the highest location. This tube allows expansion of the fuel and provides a place to add oil for priming. See Index of Drawings for Piping Schematic. For priming, be sure your waste oil is filtered, or use #2 furnace fuel. **Do not use clear, clean** 30 or 40 SAE motor oils, as ignition may be harder. **IF YOU USE CLEAR MOTOR OIL, THEN ADD** a little filtered black waste oil to help ignition, the colloidal carbon in waste oil helps ignition. If you prefer, add a little stove oil to your new 30 SAE motor oil.

Turn electrical power to furnace on, then open the bleeder valve on your pump and start the pump by switching the toggle switch to “pump on” position. Ensure that the toggle switch is moved to preheated position when finished priming the fuel lines. The toggle switch must be moved to the preheated position to burn waste oil; and wait till the green temperature-indicating lamp comes on. Wait an additional 10 minutes before starting the furnace. Close the wall thermostat to call for heat (move the temperature setting above the ambient temperature). With the air pressure set at approximately 15 PSI, the oil pressure at 3 PSI and the air blast tube adjustment at approximately $\frac{3}{4}$ inch slot opening (not interpreted as $\frac{3}{4}$ of the way open), the burner will fire up.

REMEMBER THE PUMP TURNS WHEN THE BURNER IS OPERATING, BUT STOPS WHEN THE BURNER SHUTS DOWN.

THE FOLLOWING IS FOR WASTE OIL BURNERS WITH NO OIL PRIMING SWITCH.

- You may put a jumper cable between the FF terminals on the oil primary control **AFTER THE BURNER STARTS**. This will continue to keep the burner and pump going until the jumper is removed. Leave this jumper on until oil comes out of the bleeder screw on the pump, and no air is spurting out of the bleeder screw. The oil must come out of the bleeder screw steadily and evenly with no spurts. If it does come out in spurts, **YOU HAVE AN AIR LEAK ON THE SUCTION SIDE OF THE PIPING AND YOU MUST CORRECT IT**, or your furnace will frequently shut down in the morning.

CAUTION: BE SURE TO REMOVE THE JUMPER CABLE WHEN FINISHED TESTING!!

- **IMPORTANT: DO NOT FIRST PUT THE JUMPER ON THE FF TERMINALS OF THE OIL PRIMARY, AS THE BURNER WILL NOT START!** Put the jumper on after the burner turns on. This will keep the burner and the pump operating whether it is burning or not – **SO BE CAREFUL!**
- Disconnect the fuel line connected to the burner and run a coffee can full of oil through, flushing the new piping and lines, while rattling the piping to dislodge debris, dust, bugs, etc.

NOTE: There is NO strainer or filter from the burner oil regulator to the nozzle. Avoid removing the nozzle by taking this precaution. IF YOU DON'T FLUSH THE LINES, YOU WILL HAVE TO CLEAN THE NOZZLE OF WHATEVER DISLODGES FROM THE FUEL DELIVERY SYSTEM!

- After ascertaining that there is compressed air to the heater, set the primary air regulator (**RECOMMENDED OPTIONAL**), if you have installed one, to 30 PSI. Set the air pressure on the burner (Regulator is on the **LEFT** side of burner) to 15 PSI. When burner is operating, set air pressure to 15 – 20 PSI for used crankcase oils. Do not exceed 20 PSI on the small BTU/hr burners. On higher KAGI BTU/Hr burners, especially models used on boilers, higher air and oil pressures are used. On the model HW350, set the air pressure to 20 PSI. Adjust the oil regulator (on right side of burner) to 3 PSI on the HW150 and HW250 and 4 – 5 PSI on the HW350. **THESE SETTINGS ARE ONLY STARTING POINTS AND WILL VARY WITH OIL VISCOSITY, WHICH CHANGES WITH OIL TEMPERATURES AND NOZZLE ORIFICE SIZE!**

NOTE: IT IS RECOMMENDED THAT WHEN LIGHTER FUELS ARE BURNED SUCH AS #1 AND #2 FURNACE FUELS, THAT A CORRECT SMALLER SIZE NOZZLE BE USED. HEATWAVE has furnished a nozzle size that meets all-around needs for waste oil burning, however, for top efficiency and good performance, install a smaller orifice nozzle when burning light furnace fuels that do not need preheating!

- Check your chimney and be sure you have draft of at least .02 inch W.C. when cold.
- Push reset button on the oil primary as it may not have been reset at the factory.
- **YOU DO NOT HAVE TO TOUCH THE PRE-HEATER SWITCH** (leave it on the up-most position) **IF YOU ARE GOING TO BURN CRANKCASE OILS AT THE START!**

Check the pre-heater switch located on the left side of the burner face where the indicating lights are and ensure that the switch is on for burning waste oil (all the way up on the three position switch), off if you use #2 Furnace fuel (center position on the switch). You **DO NOT** need to pre-heat furnace fuels when you are burning fuels such as #1 and #2. Leave the temperature setting of the pre-heater (located under the swing cover

the oil primary sits on) where the factory has it. It is usually set at approximately 140° F. If the oils you are burning are extremely thick, the temperature may increase to 145° F., NOT ANY HIGHER!

INCREASING THE PRE-HEATER TEMPERATURES HIGHER THAN FACTORY SETTINGS WILL RESULT IN COKING OF YOU PRE-HEATER AND A “TEAR DOWN CLEAN” WILL BE NECESSARY. THE TEMPERATURE SHOULD BE JUST HIGH ENOUGH FOR IGNITION AND NO MORE! If your oil is too thick (more than 50 weight SAE) dilute it with furnace fuel. You may have to add up to 20% by volume.

- Turn the main electrical breaker to your heater on. A red neon-indicating lamp will come on, warning that the burner is “ON”. Wait about 15 minutes, a thermo-disc switch will close and turn a green indicator light on. As the preheater heats up to 120° F., this normally open thermo-switch closes, energizing the green neon light. The green light indicates the preheater block is at the proper ignition temperature. Trying to start the burner before the waste oil in the preheater is at proper ignition temperature will cause the burner to misfire and malfunction.
- Turn the wall thermostat to the desired setting. The burner should fire. Refer to Burner Trouble Shooting in this manual (See Index) if ignition does not occur.

NOTE: If ignition does not occur, try lowering the atomization air pressure. Your secondary air has been preset and adjusted at the factory when your burner was bench-tested; however, if the opening is too small or too large, ignition will not occur. Try a 3/4” slot opening as a start. This is not to be interpreted as 3/4 of the way open!

NOTE AND CAUTION: If ignition does not occur, DO NOT REPEATEDLY PUSH THE RESET BUTTON. You may be spraying unburnt fuel into your combustion chamber. You can easily check oil delivery by looking into the observation port next to the burner. If you have flooded the furnace, refer in this manual to proper cleaning and unflooding of your furnace.

- AFTER THE BURNER HAS RUN FOR AWHILE AND THE CHIMNEY IS WARMED UP, ALL FOUR ADJUSTMENTS MUST BE MADE FOR GOOD IGNITION AND A COMPLETE BURN. The four adjustments that you, as an owner, must make are the air pressure, oil pressure, turret (secondary air), and the barometric damper. See Index on “Burner Adjustments”.
- A cadmium cell and oil primary are part of the safety controls on your KAGI burner and will stop the oil burner within a pre-determined number of seconds (usually 45) if the burner fails to ignite or if you have a flameout. The oil burner will not come on until the primary (red button) is reset. **NEVER PRESS THE RESET BUTTON MORE THAN TWICE IF IGNITION DOES NOT OCCUR.** Refer to start up procedures and trouble shooting in this manual. After the burner primary kicks off, **YOU WILL HAVE TO WAIT THE TIME PROGRAMMED IN THE PRIMARY CONTROL’S COMPUTER BEFORE YOU CAN PUSH AND RESET THE PRIMARY CONTROL AGAIN.**

- **WARNING! AFTER FLAMEOUT, DO NOT PUSH THE RESET BUTTON IF THE HEATER IS HOT TO TOUCH. IF VOLATILE GRAY VAPOR IS IN THE FURNACE, YOU COULD CAUSE AN EXPLOSION! WAIT UNTIL THE FURNACE IS COOL TO THE TOUCH AND NO GRAY VAPOR IS RISING.**
- After flame is established and the furnace has warmed up, a combustion air adjustment may be necessary. The altitude, location of your furnace, and the type of fuel and viscosity will necessitate different air settings for good combustion and maximum efficiency.

5.02 FURNACE SMELLS WHEN FIRST FIRED UP

The furnace may smell and smoke slightly when first fired up due to the over spray of oils and paint. Do not be concerned, as after a short time the odor will burn off and disappear.

6.00 FURNACE ADJUSTMENT AND GENERAL OPERATION GUIDELINES

(Read the following 6.01)

6.01 FURNACE CONTROLS REQUIRING ADJUSTMENT

1. Barometric Control (See Index for “Barometric Control and Adjustment”)
2. Air Pressure Regulator (See Index for “Air Regulator). Air pressure should not exceed 20 PSI on lower BTU burners. Too high a setting could prevent reliable ignition. Maximum air pressure is based on the burner nozzle size. Pull up on the locking ring on air regulator (left side of burner) and turn knob in or clockwise to increase the air pressure or counterclockwise to decrease. Reset locking ring after setting is made.
3. Oil Pressure Regulator (See Index for “Oil Regulator”). Turning the adjustment screw in or clockwise, increases the oil flow, turning the adjustment screw counterclockwise decreases the oil flow. It is **not important** that the oil gauge shows a reading. The proper pressure maybe less than 3 PSI. It can be near zero when burning #2 furnace fuels. Adjust the oil pressure by observing the flame length! (see figure 28)
4. Secondary Air Adjustment (See Index “Combustion Air Band”)
5. Combustion Air Band, Turret, Blast Tube Air, Secondary Air Adjustment. The circular band opposite the burner motor admits combustion air (generally referred to as “secondary air”) to the flame. The amount of air is regulated by loosening a band set screw and turning this band to increase the air gap between the housing and the slots in the band. Generally, too much secondary air will result I poor ignition and a lean air-fuel mixture, which will cause a loss in furnace efficiency. Too little secondary air results in a smoky, high-particulate laden flame. To obtain maximum efficiency from your furnace, adjust the band so the maximum smoke spot is #3 on the Shell-Bacharach Scale when burning crankcase oils and used transmission oils, and #2 on the scale when burning #1 and #2 furnace fuels.

6.02 ADJUSTING THE SECONDARY AIR WITHOUT A SMOKE SPOT TESTER

If a Bacharach Smoke Tester is not available, decrease the secondary air until the flame turns from yellowish to orange, and tips of black smoke appear. Slowly turn the air band and gradually admit more air in until the black wisps of smoke are gone. **DO NOT OPEN ANY FURTHER.** Lock the band set screw tight after you have made the adjustment. While a leaner flame is hotter and cleaner in a furnace, excessive secondary air will cause heat to shoot up the chimney, lowering carbon dioxide readings while raising carbon monoxide percentages.

6.02a ADJUSTING THE FLAME USING THE CAD CELL ON FURNACES WHERE THERE IS NO FLAME OBSERVATION PORT:

Caution – Wear Safety Glasses!

Adjusting the flame for top efficiency with the Cad Cell:

FOR HEATING TECHNICIANS ONLY!

The burner can be adjusted to a high burning efficiency by monitoring the flame intensity (brightness) with the cad cell. Generally a brighter flame will be a better burn. After the flame length is established, quickly disconnect the two yellow wires on the FF terminal of the oil primary control unit and install a short jump cable. If you wait too long (approximately 45 seconds) the burner will kick off and you will have to restart the burner! With the jump cable on, you have bypassed the safety feature of the cad cell and oil primary. The burner will continue to run flameout or not. Take a volt/amps multi-tester and switch to continuity testing, and connect to the yellow cad cell leads. The cad cell turns light into continuity. The brighter the light, the better continuity. You will use the cad cell as the eye, to monitor the flame to its best burn of brightness. Adjust the secondary air (combustion air or blast tube air) and the air pressure for atomization of the oil. Do not increase the oil pressure as you may put the burner in an over-firing mode. Do not exceed the factory settings on models not equipped with a soft start tank, as excessive air pressure will cause hard starting of the burner. In all cases, after setting the adjustments, turn the wall thermostat on and off, and be sure the burner will self-ignite. After the burner has operated for at least 20 minutes, keep face away and carefully open the inspection port and observe the flame length.

CAUTION! BE SURE THE JUMP CABLE IS REMOVED FROM THE FF TERMINALS ON THE OIL PRIMARY CONTROL AND THE TWO YELLOW CAD CELL WIRES ARE RECONNECTED!

6.03 ADJUSTING THE OIL PRESSURE REGULATOR

The oil regulator is located on the right side of the burner. There is a locking nut on the stem; after loosening it, turn it clockwise to increase the oil flow, turn it out or

counterclockwise to decrease the oil flow. The burning rate or flow rate can be adjusted by simply turning this screw. Too high an oil pressure reading will cause excessive furnace temperatures and an over-firing condition. Too low a setting causes the furnace to be under-fired. Rather than set the oil pressure for a particular fuel, it is best to observe the flame from the observation port. Over firing will void your warranty.

6.04 FAN SPEED

The circulation blower speed and air movement for your HEATWAVE furnace has been carefully engineered and selected for most applications of free air and minimal ducting requirements. Do not deviate from the recommended installation techniques unless you are a qualified licensed heating mechanic. If you speed up the blower for your particular needs, please heed these notes:

- The furnace should be started and allowed to come to operating temperature.
- Take an electrical current draw of the blower motor.
- If the current draw is less than the rated amperes on the motor, the speed of the blower can be increased.
- If the current draw is greater than the rated running current of the motor, then the speed must be decreased or a large horse power motor maybe needed for proper air flow and ducting pressures.
- Blower speed can be changed using different rpm motors or changing pulley sizes.

CAUTION: EXCESSIVE BLOWER SPEED WILL CAUSE THE MOTOR TO DRAW TOO MUCH CURRENT AND OVERHEAT, DAMAGING THE MOTOR.

You will have to install a higher HP motor. If a higher HP motor is chosen, be sure you have a qualified licensed electrician properly install the motor so he will not overload any electrical components of the HEATWAVE furnace.

6.05 DRAFT READINGS

LET YOUR HEATWAVE FURNACE RUN FOR AT LEAST 30 MINUTES before drilling a hole and checking the draft. The draft is checked with a manometer (liquid type) or an airflow sensitive draft meter. If you pay a heating mechanic to adjust your draft control, this is money well spent as too much draft will cause all the heat to exit up the chimney and decrease the carbon dioxide readings; too little a draft could cause furnace malfunctions that lead to a bad ignition, sooted electrodes, etc.

The HEATWAVE furnace must have a -.02 W.C. when cold and -.04 to -.06 W.C. (water column) when running hot. After adjusting the weights to the proper draft, be sure to tighten the lock nut on the draft control.

6.06 DO NOT USE POWER DRAFT BOOSTERS TO OVERCOME NEGATIVE PRESSURES IN A BUILDING USING EXHAUST FANS, CAR EXHAUSTERS, PAINT OR SPRAY BOOTHS, ETC.

Most waste oil heaters are engineered to operate on a negative draft and if this negative pressure in the building causes a downdraft through the chimney, obnoxious gases, such as carbon monoxide, will be forced back into the room. A situation like this violates building codes, as air for compensation is required when exhaust fans are used. **DO NOT TRY TO CORRECT SUCH A SITUATION WITH A POWER VENT.**

6.07 VENTING ALL COMBUSTION AIR FROM OUTDOORS TO OVERCOME NEGATIVE DRAFT AND/OR EXCESSIVE DUST

When a furnace must be installed in an area where a negative draft will be created by exhaust fans from painting booths, or by extremely dusty conditions from industrial grinding, painting, etc., outside air must be brought directly into the KAGI burner. The ambient air around the KAGI burner must be completely sealed out of the burner so there is no leakage of inside room air to the combustion blower.

On a Beckett-type burner, an optional rubber boot is available for this purpose. It completely covers and seals the burner combustion blower assembly. There is no rubber boot available for a KAGI burner; however, it is a simple matter to accomplish this. Shut off the combustion air completely by closing the opening with the adjusting band. In areas where there could be leakage, use some sealant such as silicone to make these areas airtight. Next, remove the two screws and cover plates that are on the end of the combustion blower housing opposite the motor. Use 4" pipe connectors to bring outdoor air in. Adjacent to the combustion blower opening, install a 4" adjustable damper; you may have to thread the shaft so a locking device can be installed. The combustion air will be regulated by this damper instead of by the adjusting band. Check and seal all joints on your burner and pipe, making sure that they are all airtight. KHS has available a 4" adjustable damper for your needs.

Many installers state when the combustion air is brought in through sealed pipes from the outdoors, a barometric damper is not necessary. It has been my experience, however in many cases to get the burner to operate properly, a pipe connector must be brought in horizontally from the outdoors, and a barometric damper installed outdoors. In theory, if the chimney is too tall vertically, with too much heat rising, the draft could be excessive. I suggest the draft be checked with a draft meter while the furnace is in operation; it should not exceed .08 W.C.

6.08 VIEWING THE FLAME FROM THE OBSERVATION PORT

THE OBSERVATION PORT SHOULD BE OPENED SLOWLY WITH YOUR FACE TURNED AWAY. As a safety precaution, wear a TINTED FACE SHIELD or at least an eye shield for protection should there be a backfire or a flame blow-back. The heat from burning waste oil can be in excess of 2200° F.

CAUTION: THE DOOR IS EXTREMELY HOT; USE A TOOL TO PROTECT YOUR HAND WHEN LIFTING THE DOOR. Carefully lift the door and observe the flame quickly. The flame characteristics will change almost immediately, as the opened door will change the combustion air ratio. Quickly close the door again and observe the flame before the air enters the chamber and changes the flame. Repeat this procedure several times until you are sure the observed flame is the same as before the door was opened.

6.09 OPTIMUM FLAME LENGTH (see figure 16 for flame characteristics)

NOTICE: The stainless steel chamber protection shield or ceramic target inside the combustion chamber should not glow **RED HOT**. With the burner operating for an extended period, carefully open the observation port **KEEPING YOUR FACE AWAY**, push the red reset button on the oil primary and **HOLD IT DOWN**. The burner will immediately stop. If the target is glowing **RED HOT**, you are over-firing your **HEATWAVE** furnace. Turn the oil pressure down! Do not be concerned if the pressure is not legible on your oil pressure gauge. The flame length is all that you should be concerned about. When your **HEATWAVE** furnace is properly adjusted, the tip of the flame will be $\frac{3}{4}$ of the way across the combustion chamber, occasionally touching the target. The stainless steel or ceramic target should last a long time, if you are not over-firing your furnace. This target is a replaceable part; however, avoiding abuse of the target will lengthen its life. The stainless steel and ceramic target is really not necessary, provided the furnace is not over-fired. The chamber walls are constructed of heavy 10 gauge steel; **HEATWAVE** has installed this extra stainless steel or ceramic wall to protect the chamber in case of accidental over-firing. **DO NOT OVER-FIRE YOUR FURNACE AND DESTROY THIS TARGET.**

NOTE: Adding chloride solvents to your waste oil storage tank is not only illegal but will also oxidize any stainless steel target and chamber.

6.10 FLAME LENGTH WILL INCREASE ON ITS OWN

One of the unique and useful features of the **KAGI** burner is its ability to turn the oil heating mechanism off when the burner is resting or cycled off. This feature makes the **KAGI** burner more reliable than other models as the oil heater is not cooking and coking up the oil. However, this feature is also the reason you must operate your **KAGI** burner for at least 20 minutes before the final setting. When the burner first comes on, this heating cartridge is dormant. As the burner continues to burn this cartridge heater becomes hotter and hotter. The flame lengthens, as the oil becomes hotter and thinner. This is why after the flame length is adjusted and established, in a short time the flame can lengthen on its own, overheating the target area.

It is this unique feature about the **KAGI** burner that makes it outperform other burners, especially when used in a boiler. The oil spray gets hotter and hotter with use and minimizes oil impingement on the sides of cold wet based boilers. Most waste oil burners on the market have only one oil heating element, and although the flame is good on initial start up, as the cold oil comes into the burner, thermo-efficiency is reduced and

wet oil can collect on the bottom of the boiler chamber. There should not be any black residue or oil in a boiler chamber. This indicates poor combustion and an incomplete burn of hydrocarbons.

6.11 OPTIMUM FLAME COLOR

Reading and review the section on Secondary Air Adjustment from 6.01 to 6.03. Not the flame color will be orange with some yellow. If the flame is roaring and it is white or more yellow than orange, there is too much air pressure and secondary air. Adjust it down for maximum furnace efficiency.

CAUTION: Use minimal secondary air. Too much secondary air either causes the burner to be difficult to ignite or allows excess heat loss through the chimney.

6.12 FLAME GLOWS DARK RED OR ORANGE

If your HEATWAVE furnace is emitting too much smoke, with a dark red or orange flame, the chimney and heat exchanger will become sooty and require cleaning. Your oil consumption will also be excessive.

6.13 OVER FIRING YOUR FURNACE

Over firing your furnace and keeping your target RED HOT can create a hazardous situation. Should you be burning #1 or #2 furnace fuels, which are more combustible than waste oil, a flame-out could spray explosive vapors onto this red hot target which could act as a “Glow Plug” causing an explosion. SAFETY FIRST! DO NOT OVER FIRE YOUR FURNACE.

6.14 ADJUSTABLE FLOW RATE

The HEATWAVE furnaces have the ability to adjust the flow rate for burning. This feature makes HEATWAVE furnaces the most desirable furnace on the market. Many other furnaces have a locked-in flow rate, which gives you low heat when the oil you are burning has low BTU content and the fuel is thin. Waste oil is cheaper and more available than furnace oil. With HEATWAVE, the variable oil regulator allows you to burn thin or thick oils by a simple adjustment of the oil regulator that will give the desired heat output and burning rate.

Inspect the viscosity of waste oils put into your storage tank and adjust your burner to these oils to obtain satisfactory performance from your HEATWAVE furnace.

6.15 FILTER WASTE OIL

Do not deposit waste oil into the holding tank without straining it. Cigar butts, gasket material, leaves, etc., will clog your check valve and strainer. If you do not wish to service your strainers often, take the precaution of straining the oil before dumping it into

your storage tank. Also, it maybe impossible to clean your tank of debris if your tank does not have a large cleaning access door.

6.16 FILTER WASTE OIL THROUGH A MAGNET

If your oil solenoid frequently sticks due to MAGNETIC SLUDGE, use a strainer with a built-in magnet or simply pour the waste oil over a MAGNET before depositing it. Magnetic sludge is black and looks like waste oil, however it will mover with a pencil magnet. Most manufacturers use a magnetic oil solenoid which is exposed to the oil flow and this collects the magnetic sludge, causing malfunction of your oil solenoid.

6.17 ADDING THIN FUEL OIL TO WASTE OIL SUPPLY

CAUTION: If you run out of waste oil and your storage tank is refilled with #2 furnace fuels, you may have to readjust your burner. If your regulator is set for the thicker waste oils, introducing thin oils on this adjustment will put your furnace in an over firing mode. If you add thin oils to your supply tank, it will take at least eight hours for the different viscosity fuels to mix, longer if the oil temperature is low. You must agitate and mix this oil in the storage tank to avoid resetting your burner adjustments. For best results, use compressed air to mix your oil. Check your flame length, it may have changed.

6.18 BURNING REAR END GREASE

Your HEATWAVE furnace is not safety-tested or listed to burn rear end grease. The highest permissible viscosity by weight is 50 SAE.

Does rear end grease burn? YES, but the ash build-up is faster as these types of oils have a higher ash content. Many owners dilute these thicker oils with #2 furnace fuels by 20% and successfully burn them. KAGI does not recommend burning rear end grease due to the high ash residue.

6.19 BURNING SYNTHETIC, COOKING, AND OTHER OILS

Many people ask if a KAGI burner will burn synthetic oils such as Ams-oil? Many synthetic oils have a higher flash point and do not burn as well by themselves. The common oils with the lower flash points burn better. Clear new motor oils behave the same way, and do not ignite as well as dirty black waste oils. The colloidal carbon in waste oil helps the arc ignite the oil. If you wish to burn new clear motor oils, it is best to add a little black waste oil to help ignition. Fortunately, these oils are all miscible with motor oil and other combustible oils and will all mix together and burn. Many KAGI burner owners have reported they have successfully burned a mixture of up to 20% #2 furnace fuels added to synthetic oils. There are expensive synthetic oils that will not burn as it is **NOT** an oil-based hydrocarbon. Roll up a piece of newspaper, and dip it into your unknown test oil, light it and see if it burns. For burning cooking oils and bio-fuels, call KHS for information.

WARNING! HEATWAVE does not recommend burning anything other than crankcase oils, used transmission fluids, and #1 and #2 furnace fuels in their HW150 and HW250 furnaces. The same on the HW350 with the exception of burning only #2 furnace fuel instead of #1 furnace fuels. Only these oils have been tested in the HEATWAVE Multi-Fueled Furnace by ETL, a nationally recognized safety testing laboratory.

CAUTION: HEATWAVE takes no responsibility for damage caused by burning anything other than recommended and SAFETY TESTED fuels in the HEATWAVE furnace. The information in this manual is provided to educate the owner, and answer questions that are repeatedly asked, NOT to encourage the owner to do things contrary to the recommendations of the safety test lab and the manufacturer.

7.00 CHECKS AND MAINTENANCE

While you should not attempt to repair your HEATWAVE furnace, you can perform simple checks and maintenance to encourage efficient performance and determine what might be wrong in the event of a malfunction.

7.01 MAINTENANCE AND SERVICE

Your service and maintenance will depend on how much you use your HEATWAVE furnace and the contaminants that are present in your fuel. A HEATWAVE furnace is NOT a heater requiring arduous daily care. After using and maintaining your HEATWAVE furnace for awhile, you will automatically be able to determine what should be done and how often. If you were to burn clean, new #2 furnace fuel day after day, you would never clean the furnace filters or the dust chambers. HEATWAVE does not insist on daily maintenance, as common sense will usually (but not always) tell you when certain things should be checked. If your shop has a problem with water in the airlines and no water traps are installed, your KAGI burner will perform just fine provided you keep the water out of the burner. The frequency with which the water should be drained would depend on the time it takes to develop enough water in the system to cause problems. It could be daily, or even monthly. As the manufacturer, we recommend dust cleaning sooner than it probably will be necessary, but frequent inspection, if not cleaning, is a beneficial safety precaution. HEATWAVE will advise various “add-ons” to minimize maintenance on your HEATWAVE furnace. These recommended add-ons have been developed from information that has been gathered by observing furnaces installed by professional heating mechanics through the years.

7.02 USING STACK TEMPERATURE FOR DETERMINING WHEN DUST CLEAN-OUT IS NEEDED.

Your HEATWAVE furnace when clean will have a high efficiency and a stack temperature of about 450° F. As the dust accumulates in the chamber, on the sides of the heat exchanger and in the flue tubes, it acts as an insulator and reduces the furnace efficiency. The stack temperature will continue to rise until it may exceed 750° F. You can install a stack thermometer permanently in the stack of your furnace and use the

indicated temperatures as a guide to determine when to clean your furnace. Otherwise, dust removal from your chamber flue tubes, stack, and heater exchanger should be part of the monthly maintenance. Examining these areas will tell you much about the oil you are burning and the extent of the cleaning that needs to be done. Every 55 gallons of waste oil burnt can produce approximately one pint of dust. Stainless steel stack thermometers are available from Kagi Heating Supplies & Manufacturing, Inc. (1-888-866-5244 toll free)

7.03 PROTECTIVE CLOTHING AND INDUSTRIAL DUST MASKS MUST BE WORN WHILE ATTEMPTING TO CLEAN THE DUST OUT

Most of what constitutes the dust that accumulates from burning waste oil is silica ash. Waste oil can contain undesirable heavy metals such as lead and cadmium; however, except for lead, the particles are extremely minute. Even the lead, which comes from fuel, is being slowly eliminated by replacement with substitutes such as alcohol to raise the octane rating and remove the need of lead to raise the octane rating of fuel. Since waste oil is variable and many foreign things can be in it, avoid any contact with it and dispose of it properly.

7.04 DUST REMOVAL FROM 2ND CLEANOUT DOOR: CAUTION!

To minimize dust removal chores, HEATWAVE has provided two dust clean-out doors on every model furnace manufactured by HEATWAVE. Many competitive models have only one clean-out door and the chimney must be removed for access to the dust chamber, making dust removal arduous. With a HEATWAVE furnace, when the dust door on the burner side is removed, the dust in the flue tubes can be pushed away and dropped to the rear and removed with a vacuum cleaner. See Figures 45 & 46.

THIS ACCUMULATION MUST BE COMPLETELY REMOVED or it will seriously restrict or deflect the exhaust draft and overheat certain parts of the chamber. The internal baffle that separates the primary and secondary flue tubes could burn out, causing dangerously high stack temperatures.

This dust that has dropped to the rear can be removed with a vacuum cleaner through the burner mounting hole or the inspection port. For thorough cleaning, the chimney side dust door should be removed occasionally.

Remember a clean, dust-free furnace will operate more efficiently as the dust is a good insulator of heat and will not allow the heat to transfer to the air jacket. The heat will go up the chimney instead of heating the room.

CAUTION! OPERATING YOUR HEATWAVE FURNACE WITH DUST CLOGGING THE FLUE TUBES WILL RESULT IN POOR HEAT OUTPUT AND CAUSING CRACKS AND WARPING OF THE CHAMBER AND DUST DOORS.

We again recommend a permanent installation of a thermometer registering up to 1200° F. to monitor exhaust flue temperatures and over-firing of the HEATWAVE furnace and/or excess accumulation of dust.

7.05 MAINTENANCE SCHEDULE

- **DAILY**

1. Inspect flame length for over-firing and adjust the air pressure, oil pressure, and secondary air accordingly. For burner control layout see Figure #6, Figure #16 for flame characteristics.
2. Inspect flame color and adjust according to instructions.

- **WEEKLY**

1. Inspect oil lines, pump pressure and vacuum, airlines for water, and oil filters for fuel flow. Clean if necessary.

NOTE: If these daily and weekly maintenance procedures are carried out, most of the adjustments will be constant and need no alteration. HEATWAVE furnaces are reliable, requiring minimal service compared to other makes. Many owners' report not touching their KAGI burners all season. As the manufacturer, we are concerned about safety and the prevention of problems and therefore ask that these inspections be carried out. Extensive, costly damages can be avoided by taking care of things before they happen.

- **MONTHLY**

1. Check blowers belt adjustment and adjust if it is loose.
2. Check stack temperature; if over 750° F. and you are NOT OVER-FIRING your furnace, clean the dust out of your flue and combustion chamber. The stack temperature on a HEATWAVE furnace hovers around 450° F. on a normal burn. You may have to clean the flue and dust chambers in your furnace two or three times a season, depending on the frequency of use and the contaminants in your oil.
3. Check draft with draft meter and adjust if it is off the recommended setting.

- **END OF THE SEASON**

1. Clean furnace and flue pipes. See recommendations in section on "Seasonal Cleaning".
2. Flush lines, filters, and pump with #2 furnace fuel.
3. Turn wall thermostat to "open" and "off" position.
4. Spray light oil inside and outside of chamber and parts to prevent corrosion.
5. Turn off power to the furnace from the breaker panel.
6. Clean your oil storage tank, strainers, and check valve.

7.06 SEASONAL CLEANING

Seasonal cleaning should be performed AT LEAST ONCE each heating season, even if the furnace is functioning well. See figure 45-46. Waste oil that is excessively dirty may dictate that the furnace be cleaned more frequently. Follow the steps below to do your seasonal cleaning:

1. Turn the wall thermostat to open or off.
2. Turn off the power to the furnace from the breaker panel, making sure there is no current to the furnace.
3. Shut off the air supply to the furnace.
4. Put on dust mask, eye protection and protective clothing.
5. Remove the chimney flue, inspect and clean out the dust.
6. Leaving the exhaust flue off, remove the cabinet door clamps on the chimney side of the furnace, and remove the panel to expose the dust clean-out doors. Do the same on the opposite side. Remove the brass nuts on the clamps securing the dust chamber doors. The internal flue tubes, filled with dust, will be exposed. With a vacuum cleaner and suitable round brush, remove this dust. KHS stocks 8 inch chimney and 4 inch flue brushes for the HEATWAVE furnace.

The dust is not bonded onto the sides of the flue tubes, but a little gentle brushing will be needed to remove this dust.

Remove the nuts that secure the burner onto the universal flange and all the energizing power wires, including the wall thermostat wires. Next, disconnect your air and oil supply line. Remove the burner. Clean whatever dust is accessible through the burner flange opening. Check for “clinker” build-up in front of the burner tube. Open the observation port next to the burner and remove any dust and clinkers. If there is black coal-like residue in the chamber, the burner is probably not giving you a complete burn of your fuel. Go through the basic adjustment, and if you are not able to eliminate this black clinker build-up, check the oil cartridge heater to see if it is burnt out (this is the cal rod heater closest to the Oil Regulator). Disconnect the wires and see if the heating element is “open” using a continuity tester.

The air pre-heater is the one to your right and is easy to check for failure. If the aluminum block is hot and uncomfortable to the touch, it is working and not burnt out (see figure 42 for heat element checkout). It may, however, not be up to its proper temperature, check the aluminum block heater with an accurate pyrometer to see if the actual temperature is lower than the indicated temperature on block thermostat. It should read 160° F. Adjust the thermostat, using your pyrometer and not the differential. The thermostat may be working but not accurate.

The residue in the chamber should be a yellowish-gray ash and not difficult to clean out. With the dust door removed on the chimney stack side, you now have access to the dust opposite the burner. Remove the dust as it acts as an insulator. It will also soak up any wet oil from flame impingement or flooding, make cleaning difficult.

NOTE: One of the advantages of the HEATWAVE furnace over others is the second dust clean-out door, which is opposite the exhaust stack. Removing the chimney flue is not necessary for periodically cleaning the internal flue tubes. Removing the chimney flue is added work and much of the dust can be removed in between seasonal cleaning. A little experience monitoring the dust build-up will help determine when both clean-out doors should be removed.

7. Replace the chamber doors carefully; making sure the gasket material is not broken and a good seal is made. Replace this seal gasket if it is questionable.

NOTE: There should be NO combustion chamber air leaks, as proper burner and furnace adjustments will be hard to make and the combustion efficiency will drop.

8. Replace the panels on the side to original positions and replace the flue tube dust cover making sure all the screws holding each section are secure.
9. Set the barometric draft control both horizontally and vertically using a spirit level, making sure it swings freely.
10. Remove the set screw or screws that secure the retention head to the blast tube and slide the retention head off. Clean the carbon from it by using a propane torch and heat it red hot and burn the debris off. Do not worry about overheating the retention head, as it is constructed of stainless steel.
11. Remove the nozzle and completely disassemble it, using an old toothbrush to clean the grooves in the oil distributor. See the expanded view drawing of the nozzle. (Figure #12) If you use a blow gun, be careful not to blow away the small stainless steel oil distributor, as it cannot be bought separately. Be sure to clean the **inside** of the nozzle assembly, and the cap. Any carbon here will cause your oil spray to go sideways and cause oil impingement and poor-to-hard ignition. Do not use a drill or any sharp instrument to clean the orifice. Check the "O" ring on the fluted stem and replace if loose in the bore. Observe the roundness of the discharge orifice; if it appears to be egg shaped, replace the nozzle. Check for arcing from the electrodes. The abrasive material in waste oil does wear the nozzle out. The nozzle should be replaced at least every two heating seasons.

CAUTION: DO NOT TURN THE NOZZLE WITHOUT HOLDING THE NOZZLE HOLDER AS YOU WILL TWIST AND BREAK THE ELECTRODES!

Remove the hold-down screw that secures the transformer and tilt the transformer back, exposing the buss bars and rear of the electrodes. Clean the insulators of the electrodes. Dust accumulation here will ground the electrical spark and cause hard-starting to no-ignition.

Turn the burner around and clean the front insulators of the electrodes. Clean the electrodes with steel wool and check and re-adjust to the proper gap, matching the

drawing of the electrodes. See Index of Drawings (Figure #13). Check electrode porcelain for damage and cracks. If the electrodes are cracked or worn, replace them.

Remove the oil heating element by first cutting the wire that goes to the pre-heater switch. However, do not cut it too short, as on assembly we will use an insulated wire connector. The other wire of the heating element connects to terminal 4 or 5 (load terminal). Remove the oil-heating element using a 6 pt. 7/8" deep socket. There are two heating elements; oil heater on the left, air heater on the right. Take out the cartridge heater and wipe off all debris, then buff. Wipe out the inside of the bore with a cloth. Use a bottlebrush or better yet, a 12 gauge shotgun brush. The carbon and debris will not be hard to remove. Blow out the heater well with compressed air and replace the heater, using thread compound on the coarse threads. The other element heats the compressed air supply and seldom needs removal and cleaning. Should water or rust pass into your burner, you would need to remove this unit and clean the passageways.

CALL Kagi Heating Supplies & Manufacturing, Inc. on what is necessary to thoroughly clean the oil passages on the KAGI burner.

Next, disassemble the oil solenoid valve and clean. If you use a blow gun, first remove the rubber o-ring from the brass body, as it is hard to find locally. This is the valve with an electrical coil over the valve. There are two solenoids used on KAGI burners and both are similar in appearance. It is not necessary to clean the air solenoid unless there are symptoms that demand it be cleaned. With a 5/16" or 8 MM open end wrench, turn the flat end of the valve body counterclockwise and remove.

Depending on the location of the spool, it is usually not necessary to remove the spool to get access to the valve body. With the valve body removed, clean the piston and valve body bore. Be sure after the piston is cleaned, it slides freely inside the bore. Lubricate with WD-40 oil. Be sure the spring is on the end of the oil piston and the rubber tip end down into the solenoid body.

CAUTION: DO NOT USE CARBURETOR CLEANER ON THE RUBBER VALVE

Soaking the piston in carburetor cleaner may swell and damage this rubber disk. Replace the whole valve, if it binds in the bore. Inspect the rubber disk on the end of the piston and if it is grooved deeply or appears it will not seal properly, replace it. A bad seal here will cause post-nozzle drip. Any part of the solenoid can be purchased separately from KHS.

CAUTION: Remove "O" ring inside the valve body before you use an air blow gun as you may blow it away. This "O" ring is of a special thickness and if it is lost you may have trouble replacing it locally. Use a rubber-tipped air blow gun and with the valve stem removed, blow through the oil passage and clean what you can. Assemble the valve body back together and make sure the rubber disc of the piston faces down. Do not over-tighten the brass piston/stem housing.

Mark the secondary air band for location and remove. Remove the dust cover on the end of the aluminum burner housing to expose the burner squirrel cage blower. Clean the lint and dust off the blades. These blades lose their air moving efficiency if dirty and clogged, clean blades, replace band, and cover.

Set the transformer down and secure hold-down screw. Replace retention head, making sure the air gap around the electrodes is more than the gap between the electrodes, so that it will not short out. Install the burner back to the furnace flange, hook up air lines, burner power cord or wires, including the wall thermostat wires, as they were before. Look at the wiring schematic on the older models if you are uncertain as to where the wires were formerly attached. On the new HEATWAVE models, plug in the burner electrical cord.

Clean the fuel filters, screen in the transfer pump and the primary air regulator (most have a water trap and filter screen), and sediment bowl on the air regulator, if your model has one. Remove the storage tank screen and clean the suction strainer and check valve. Drain any water from your above ground storage tank, and if you have an outdoor buried tank, have a tank clean-out specialist remove the water and sludge and properly dispose of it. Prime your lines and pipes, and bleed the fuel system.

Take a shop-vac and clean the blades on the circulation blower as was done on the burner combustion blower wheel. Any dust or debris stuck to the blades will cause unwanted noise, vibration, and a drop in air discharge speed.

Inspect the blower fan belt for wear and cracks, and replace if questionable; adjust the belt, referring to the drawings on belt and pulley alignment and adjustment (See Index of Drawings #25).

Follow the start-up checklist, furnace adjustment, and flame adjustment, respectively, in this manual to prepare the heater for start-up.

If the furnace is to be shut down for an extended period, turn off the power to the furnace and spray the inside and outside of the combustion chamber with light oil to prevent oxidation.

SEE SECTION INDEX FOR MAINTENANCE AND CAUTION DECALS

7.07 BURNER CLEANING

KAGI burners have the reputation of operating as long as three to five years without touching the burner. KAGI burners have a unique pre-heater design that has been tested in the field for over seven years.

If your KAGI burner has been operating with a lessened draft due to dust accumulation or improper secondary air adjustment, there may be coking on the retention head (the stainless steel cap with blades around the nozzle). You can easily check this by removing

the transformer hold-down screw, tilting the transformer back, and shining a flashlight inside. If the retention head is dirty, you must clean it, as this build-up will eventually short the electrodes. Any restriction here will lower burning efficiency.

Remove the burner, and then remove the screw/screws that hold the retention cap on the blast tube, slide off the retention head and clean. If the blast tube and retention head is not too dirty you can take a propane burner and heat the retention head until it is red hot and blast it with an air gun. It is constructed of stainless steel so heating it red hot will not damage it. If you remove the retention head, be sure to replace it in such a way that the electrodes are not shorted. Look at the electrode drawing (Figure #13) and be sure that the gap between the electrodes is less than any air gap between the electrodes and ground. Should the electrode be close to the nozzle, a shorting spark there will soon erode and destroy the nozzle. Whenever the burner is removed, take a 5/8" socket wrench and remove the nozzle; disassemble it and clean. Study the drawing of the nozzle, or look in the table of contents for "Nozzle: Exploded View" (Figure #12).

CAUTION: DO NOT TURN THE NOZZLE WITHOUT HOLDING THE NOZZLE HOLDER AS YOU WILL TWIST AND BREAK THE ELECTRODES!

7.08 CLEANING STRAINER IN WASTE OIL TRANSFER PUMP (see fig. 18-22)

Every pump, with the exception of the Webster pump, has a screen or filter to protect the internal gears. The Webster pump is a grinder type pump and does not require disassembly or cleaning. If your pump becomes noisy or excessively hot, and the pressure flow rate is decreased, your pump screen may be dirty. The cover plate on a Suntec, Combu, or Delta pump has a built in cover filter screen after the demand port. Remove the cover, being careful not to damage the gasket surfaces. Remove the screen, wash in solvent, and blow out. Use a new cover gasket. However, if you must use the old one be sure the gasket is not damaged. If questionable, you better wait for a new one. This is an example where a vacuum and pressure gauge installed on your pump would be helpful in diagnosing. A vacuum leak or oil pressure drop can be discovered quickly with these gauges installed on the pump. Many manufacturers do not mention the presence of this pump screen and the importance of cleaning it. Perhaps the pump manufacturers know a finer filter than what is in their pumps is usually furnished and installed by their vendors (on the suction side to protect the pump) is the reason. It is common to find the pre-pump filters dirty and the pump screen clean. In time, the pump screen will get dirty, plug up and make the pump inoperable. Some of the debris is long and "football shaped" flowing through the pre-filters, only to stop sideways and clog the pump screen. NOTE: The round hollow plastic disks that are in some Suntec J3 pumps are collapsible and are installed to absorb sound.

7.09 CLEANING THE SUCTION STRAINER IN THE STORAGE TANK

Some inspectors will **NOT** allow check valves and strainers to be installed in a buried tank, as they would be difficult to remove and service. If you do have a suction strainer and a check valve in your tank, use a stainless steel cloth strainer rather than a brass one

for longevity. Many manufacturers furnish a brass strainer, which works satisfactorily. However, if you suspect your waste oil is high in acid, use the stainless cloth design. Waste oil can have a high sulfuric acid content that will eat the brass cloth.

7.10 CLEANING THE OIL FILTERS (see figure 24)

The oil filters should be inspected or cleaned every 30 days of furnace operation. Depending on the cleanliness of the fuel, the size of the tank, and the agitation of sediment, this procedure may have to be performed more frequently. Monitoring the condition of your oil filters during the first few months of operation will enable you to determine the frequency of filter cleaning necessary. A vacuum gauge installed on the oil pump or oil filter will help you determine when the filters are dirty. After all the filters and strainers are cleaned, mark the reading on the vacuum gauge. It will vary depending on the viscosity of the oil, temperature of the oil and the flow resistance to the pump. The reading when everything is cleaned will be your “zero” starting point. (Cleaning can be determined when there is a rise in the vacuum reading). Don’t operate your pump with too high a vacuum reading, as it is hard on the pump. Do not exceed 18” HG.

NOTE: For longevity of your vacuum gauge, do not leave a constant vacuum on your gauge. Install a petcock so you can turn on the petcock, take a reading, and then turn it off. **A constant vacuum on any vacuum gauge will ruin it.** The above is not really necessary but KHS has a variety of vacuum gauges for sale.

FOLLOW THESE PROCEDURES FOR CLEANING OIL FILTERS:

1. Disconnect the power to your furnace or the pump.
2. Disassemble the oil filters.
3. Rinse the screen and container with solvent
4. Air dry the screen and housing.
5. Carefully inspect the screen for tears and leaks. Replace filter element if damaged.
6. Re-assemble the filters properly, ensuring the rubber gaskets are secure.
7. Fill lines with filtered waste oil or stove oil, open bleed screw on the pump; energize pump and bleed. (See Table of Contents for information on how to prime pump and system).

7.11 CLEANING THE NOZZLE (see figure 12)

To prevent blockage to the nozzle, the fuel and air must be filtered. **THERE IS NO STRAINER OR FILTER BETWEEN WHERE THE OIL ENTERS BURNER AND EXITS THE NOZZLE.** Any small debris will eventually clog the nozzle.

PERFORM THE FOLLOWING STEPS:

1. Turn off the power to the furnace at the breaker panel, making sure no current will go to the furnace.
2. Remove the wiring, air supply line, wall thermostat wires, burner flange bolts, and whatever is attached to your burner, and remove the burner.
3. Put a 5/8" socket wrench on nozzle assembly while holding the nozzle holder.
(CAUTION: DO NOT TURN NOZZLE WITHOUT HOLDING THE NOZZLE HOLDER AS YOU WILL TWIST AND BREAK THE ELECTRODES!)
4. Carefully remove the nozzle without disturbing the electrodes.
5. Disassemble the nozzle over a table so as not to lose any small parts, and unscrew the fluted stem with the rubber "O" ring away from the cap. Examine the rubber "O" ring for cuts and damages, and replace if questionable. If this "O" ring is bad, as you increase the air pressure, up to 15 PSI or more, the flame will get shorter and eventually blow out. Spray the small parts with an aerosol carburetor cleaner and examine parts. If you use an air blowgun, be careful not to blow the small stainless steel oil distributor away! You will not be able to purchase this spinner separately. Do not drill out any nozzles or use a sharp instrument that could alter the orifice. Examine the inside of the cap for carbon and remove it. Obstructions will make the spray go sideways, giving bad ignition and flame impingement.
6. Reassemble the nozzle holding the fluted member up putting the small oil distributor down into the bore. Hold the fluted member up and do not turn it upside down as it will fall out and lodge sideways inside the cap. Screw the cap down, holding the nozzle upright, and when the cap touches the oil distributor and there is no danger that it will not dislodge out. Hold the fluted member with a crescent wrench and tighten the cap. (CAUTION: DO NOT OVERTIGHTEN – THE TORQUE IS 4 INCH POUNDS).
7. Place a little grease on the nozzle O-ring to protect it and replace the nozzle in the burner nozzle holder, holding the nozzle holder so, the electrodes will not twist. Avoid touching the electrodes.
8. Check the electrode spacing. (See Figure #13 in the back of Owner's Manual).
9. Install the burner, connecting all airlines, oil lines, electrical wires, and flange nuts and bolts.

7.13 CLEANING LINES, SOLENOIDS, AND PREHEATER BLOCK

If your lines need cleaning, use furnace fuels such as #2 as they contain a cleaning detergent. Use a rubber tip blow gun to blow out the lines. Flushing your entire fuel piping system with new furnace fuel will keep the inside from sludging.

- **SOLENOIDS**
 1. Do not remove snap ring.
 2. Unscrew valve body from the solenoid base using an 8mm open end wrench.
 3. Clean body and piston with solvents. Do not use carburetor cleaner on the piston, as it will destroy the rubber-sealing disk. Remove the special rubber O-ring in the brass body before you blow out with air. This size O-

ring may be difficult for you to find locally and other thicker ones won't work. Do not distort the valve body by over tightening it. (See Figure #9).

- **PREHEATER**

The aluminum pre-heater seldom needs to be disassembled for cleaning. If it is restricted because paint or some unfriendly fluids were passed through it, send the pre-heater back to the manufacturer (Kagi Heating Supplies and Manufacturing, Inc.) for service. If it is urgent it be cleaned on the job, it is not necessary to remove it from the burner electrical box. First, try flowing carburetor cleaner or lacquer solvents through it before removing the Allen seal plugs for wire brushing the oil passages. If the steel Allen plugs are to be removed from the block for cleaning, be sure the block is heated up before attempting to remove the Allen plugs.

REASON: The heat expansion co-efficient of aluminum is greater than steel. On stubborn frozen steel Allen plugs, an acetylene torch flame right on the plug works well. This heat will breakdown the sealant and expand the hole. Use an industrial grade Allen screw wrench. If you stripped the Allen head plug, call KHS for removing instructions.

CAUTION: REPEAT! Use a high quality industrial-type Allen wrench, as these plugs can be extremely tight. After heating the plug, smack it hard with an impact driver.

7.14 CLEANING THE CAD CELL

Remove the transformer hold-down screw and flip the transformer back on its hinge. The cad cell is now visible. It is the switch with two yellow wires connected to it. The body is black and the "eye" of the cad cell pulls off. However, it maybe a model that the eye does not disconnect from the cad-cell body.

7.15 CHECKING THE CAD CELL

1. With the burner operating, turn the oil regulator screw counterclockwise and shut the oil supply off.
2. When there is flame-out, the primary oil safety switch locks out after 15 – 45 seconds (the time in seconds depends on the model primary control).
3. Adjust oil regulator back to original burning position.
4. Disconnect the cad cell leads. These are the two yellow wires on the primary control, which are connected to the terminals marked F-F. Start the burner first and immediately jump the F-F terminals. **NOTE:** Do NOT connect the jumper first, as the burner will not start. With a flame established in the combustion chamber, measure the cad cell resistance with an ohmmeter. The resistance should be in the range of 300 – 1000 ohms. Due to the difference in cad cells, the ohms will vary. However, the method of checking and its function will not

change. Generally, if the resistance is a greater then 1600 ohms, the cad cell needs only cleaning. Make sure the cad cell which is located under the transformer has a clear view of the flame. Check its position and adjust it so, it is pointed at the flame as directly as possible. Look up more information under CAD CELL in your index and study its function for better diagnosing.

7.16 OIL PRIMARY RELAY TEST

An oil primary relay test will determine if a control problem is present in the relay or in the cad cell sensor (figure 11):

1. With the power off, disconnect sensor lead wires at the relay.
2. Connect a 1500-ohm, ½ watt resistor (available at Radio Shack or similar electronics store), if the oil primary is a Honeywell, across the sensor terminals of the relay. With the power on, initiate a call for heat. The burner should not start.
3. Remove one lead of the resistor. The burner should start. Immediately reconnect the lead. The burner should run without locking out on safety.
4. Again, remove one lead of the resistor. The relay should go off on safety within its normal lockout time.

A primary control that responds as described above is functional. If it does not, it may be defective. Call a KAGI Service Technician for assistance.

7.17 CAD CELL SENSOR TEST

Remove yellow lead wires from relay. Connect an ohmmeter across the disconnected lead wires. Resistance values will be affected by a dirty cell face, and open circuit, misalignment of cell, insufficient light or a bad cell.

CAD CELL RESISTANCE VALUES IN RELATION TO LIGHT

When taking cell readings, NEVER CONNECT OHMMETER TO THE SENSOR TERMINALS OF THE RELAY. Take all readings across the sensor leads, but only when they are disconnected from the relay.

- NORMAL RESISTANCE FOR BURNER START UP: 5000 ohm or higher is considered good for normal firing.
- NORMAL RESISTANCE FOR BURNING OPERATING: Cell resistance should not exceed 750 ohms.
- NOTE: WITH BURNER OPERATING: The resistance should be 750 ohms or lower of a shutdown will occur.
- DROP OUT POINT – BURNER OFF: False or outside light strong enough to drop resistance below 10,000 ohm can prevent flame relay from dropping out after flame cut off which will block the next starting cycle.
- MINIMUM FALSE LIGHT RESISTANCE – BURNER OFF: Cell resistance on a good job should not drop below 20,000 ohm from false outside light (i.e., light

reflected through air shutter around cover plate or any crack or opening in the unit).

- NORMAL DARK CELL RESISTANCE

	A	B	C	D	E	F
0 – OHM	300	750	1000	10000	20000	1000000
CELL RESISTANCE	BRIGHT	BRIGHT	BRIGHT	LIGHT	DARK	DARK

7.18 CHECKING THE BLOWER PULLEY

Pulley alignment is accomplished by the horizontal position of the blower motor on the bracket, which has oblong holes. A straight-edge can be used to move the motor into the right position. If the alignment is off to the eye, it is excessive and will cause premature belt and motor bearing wear. Lay the shorter end of a carpenter square along the case of the motor and adjust the position of the motor pulley until the longer leg of the square is parallel to the belt. Pulley alignment should be checked if the pulleys are changed for different ratios. Inspect the alignment about twice a season. See figure 25.

7.19 BLOWER BELT TENSION

Too much tension on a belt drive will shorten bearings and belt life and too little will cause slippage, wearing pulleys and destroying belts. Too little tension will also lower the efficiency of the blower. If the belt is slipping, a higher temperature will be noticed on the furnace output with the slower air movement. The two pulleys and the belt must be tightened to correct it. It is recommended that the belt tension be checked twice a season and adjusted if necessary. The tension is adjusted by the length of the adjusting bolt and lock nut, against its stop, on the hinged motor bracket plate. (Check Index of Drawings for belt tension illustration). A deflection of approximately ½” per foot of span should be obtained by pressing the belt firmly. Be sure to recheck the tension, especially if the belt has been replaced, as new belts will stretch shortly after being installed. (See Figure #24 in Index of Drawings for illustration).

7.20 REMOVAL OF ACCUMULATED EXCESS OIL

1. Turn the room thermostat to “open” or “off” position.
2. Allow the furnace to cool to room temperature, and then shut off the furnace at the main breaker.
3. Shut off the air supply to the furnace.
4. Open the combustion chamber dust cover. (See “Dust Removal” in Index for Directions).
5. Remove excess wet oil from the bottom of the firing chamber on the bottom and sides and wipe off all excess oil with a cloth. Some access is available from the burner observation port.

6. Replace the dust cover door to its original position.
7. Reconnect the air supply.
8. Turn on the power to the furnace.
9. Follow procedures on how to operate a furnace that has had wet oil in the combustion chamber. (See Index on “Flooded Furnace”).

7.21 CHECKING THE OIL PRIMARY CONTROL (see figure 11)

CAUTION: BE SURE THAT THE COMBUSTION CHAMBER IS FREE OF OIL AND VAPOR BEFORE PROCEEDING.

- **TEST FOR FLAME FAILURE**
 1. While the furnace is running, stop the oil spray/flow by turning the oil regulator to the off position (turns the oil regulator screw counterclockwise). 15 to 45 seconds after the flame goes out, the safety switch should trip and the burner should stop.
 2. Reset the primary. (This is the red button on the gray or black box on top of the burner).

- **TEST FOR IGNITION FAILURE**
 1. With the furnace cold, turn OFF the power to the furnace.
 2. Turn the wall thermostat up above ambient room temperature.
 3. Disconnect power to the oil pump.
 4. Turn on the power to the furnace. The burner will start but without power to the pump there will be no oil and no flame. The safety switch should trip 15-45 seconds.

- **TEST FOR POWER SUPPLY**
 1. Turn the power off to the furnace while the burner is operating. When the burner goes out, restore the power and the burner should restart. If the oil primary does not operate as described in A, B, and C, above, check the wiring. If the wiring checks out, check the cad cell before replacing the oil primary. Look in the Index under “Oil Primary” and study the information on the oil primary control to better acquaint yourself with this safety switch. A good understanding of its wiring and function will help you to diagnose problems yourself and keep your HEATWAVE furnace operating at peak performance.

7.22 BLEEDING THE PUMP

See Index under “installation of Tanks, Piping, and Pumps” for more comprehensive information on the pump.

1. Prime all pipe, lines, and filters with FILTERED WASTE OIL OR #2 FURNACE FUEL. NOTE: MOST PUMPS ARE NOT SELF-PRIMING: DO NOT RUN YOU PUMP DRY!
2. Loosen bleed screw on your pump. (See figures 18-22 in the drawing section).
3. Turn the manual pump switch to the “ON” position.
4. Tighten the bleed screw if the oil comes out STEADY and SMOOTH. If no oil comes out, check the storage tank oil level and the priming you have done on the suction side, and be sure you have not created an air leak at the filters. If you continue to get air mixed with oil, check again to make sure that the fuel level in the storage tank covers the inlet port and the suction piping is completely topped with oil. If it is, inspect the SUCTION PIPING for leaks. If the oil flows smooth and steady, and every now and then a spurt of air comes out of the bleeder, THERE IS AN AIR LEAK AND YOU MUST CORRECT IT! If you do not, this small leak will cause you much grief, such as shutdowns when you least expect them. When larger pipes are used, even with pipe dope and cement on the threads, vacuum leaks will happen. Many steel unions do not use a sealant material and butt up metal to metal, which, although tight, WILL NOT SEAL. CAUTION: DO NOT USE STEEL UNIONS FOR A BREAK IN YOUR SUCTION SIDE OF YOUR FUEL LINES! Do not use this type of connector; simplify your piping by using a minimum of connectors. I recommend copper piping and soldering the unions. DO NOT USE TEFLON TAPE as pump manufacturers do not approve of its use in their pumps. Many will not warranty the pump if it is returned with Teflon tape inside the gears. REASON (from the pump manufacturers): The Teflon tape is thin and Teflon tape that is exposed on the inside of the threads will work loose into the pump.

On new installations you might check the rotation of the pump motor, as it is possible to get a motor wired to turn in the opposite direction. Some of the arrows stamped on the pump by the manufacturers may designate rotation and NOT the oil flow. Check the “U” joint coupler in case it is defective. It may be slipping on the shaft and you’ll never hear it (that is the reason for having a pump pressure gauge installed permanently at the pump). If you have a coupler that uses a serrated interior, it will slip inside if defective, and you’ll hear this one. If the above does not solve your problems, the pump will have to be checked and if defective, be replaced.

7.23 CHECKING THE OIL PUMP PROPERLY

Read Section 7.23 Owner’s Manual Carefully

If your oil pump is leaking oil from the shaft, it generally needs replacing it. If you are constantly plagued with air in the lines on the pressure side, you may NOT have a leak in the suction side of your plumbing but a leak from the pump shaft. Remove your pump and plug the out-port and allow air pressure of at least 40 PSI to be introduced into the pump. Immerse the complete pump in a container of kerosene and observe. If there is an air leak coming from the drive shaft of the pump, discard the pump. An air leak from the cover can be repaired. I have not had luck with pump repair kits. If the pump passes

these tests, disassemble the pump completely. Pay particular attention to the demand portholes to see that they are not plugged up. Always use a new cover gasket and check the cover with a file for burrs that will keep the cover from sealing. Inspect the gears for scoring. A worn gear set will not produce the vacuum needed to operate properly. Discard pump if the gears are scored. Check the drive shear pin to see if it is missing or broken. After the pump is assembled, be sure you have a pressure gauge and vacuum gauge installed to ascertain the pump condition. Use a clear plastic high-pressure pipe to observe bubbles from the pressure side. You will have to put a gate valve on the intake side after the pump is primed and operating, for checking purposes. If the vacuum is low (under 18") or there are bubbles coming out from the pressure side (when the gate valve is opened on the intake port), your pump is defective; it is sucking air in from the shaft. The shaft may not leak under pressure; however, the way the seals are made to seal the shaft, they can be defective – sucking in air but still holding some pressure. NOTE: Always put oil into the pump cover after cleaning the pump and screen. You will encounter difficulty bleeding the pump if you fail to add oil. All new pumps come sealed full of oil!

7.24 CHECKING THE OIL REGULATORS: (see figure 15)

1. Check to see if the oil flow is entering at the right port. The regulators are easily disassembled and the mechanics of the oil-flow can be found when they are opened up. KAGI Manufacturing bench tests and checks each burner. However, a part could have been borrowed or put on the wrong way by a technician. Don't take anything for granted! The inlet for the oil is stamped "IN" on the bottom of the oil regulator. There is only one inlet and three outlet ports. I have seen burners where the owner could not regulate the flame down. The oil was piped into the wrong port! The burner was operating from the by-pass pressure from the fuel pump! The pressure to the nozzle was coming in at 40 PSI.
2. Check for oil pressure at the intake port of the regulator. Crack the fitting loose and inspect for pressure. If there is not or low pressure, follow the flow back and correct it.
3. Check for outlet fluctuations from the regulator. If there are fluctuations on the output, then check the inlet source for fluctuations. If it is the oil regulator, check the oil supply all the way to the pump and tank. If it is the air regulator, check the air supply clear to the compressor.
4. Take the regulator apart, it is simple in design, clean the parts thoroughly, and reassemble. If the regulator is defective, install a repair kit from KHS or replace it with a new one.

7.25 CHECKING THE TRANSFORMER

CAUTION: HIGH VOLTAGE CAN BE DANGEROUS, PROCEED WITH EXTREME CAUTION!!!

1. Remove the hold-down screw securing the transformer.

2. Flip the transformer back and upside down, exposing the underside and wires. The studs carry the high voltage current onto the brass buss bars.
3. Follow the two wires (Usually one white and one blue) and disconnect at the terminals; check with a high voltage transformer tester. This is a universal 14,000 volt transformer that is used on all models. If you do not have access to a tester, do the following:
 - **DO NOT DISCONNECT** the energizing wires from the transformer; get a screwdriver with a die-electric plastic or rubber handle.
 - Turn the oil regulator counterclockwise to shut the oil flow off so not oil will spray out of the nozzle during the test.

CAUTION: DANGER HIGH VOLTAGE AT THE TRANSFORMER HIGH TENSION TERMINALS: MAKE SURE THE SCREWDRIVER IS WELL INSULATED!

CAUTION: DO NOT TOUCH THE TRANSFORMER HIGH TERMINALS WHEN THE BURNER IS OPERATING OR LET IT ARC TO ANY BURNER COMPONENT.

- Cross the two terminals with a screwdriver. **DANGER: HIGH VOLTAGE!** Make sure the screwdriver has a good insulated handle.
- Turn the burner on. Move the screwdriver away from one terminal.
- If the transformer is good and generating high voltage, you will get a strong arc between the tip of the screwdriver and transformer terminal. It will jump an arc automatically ½” or more away from these two points and a good transformer will pull an arc a good 1” to 2” apart before losing the arc. If it won’t jump a ½” or follow a larger gap, the transformer is weak and must be replaced. Do the same test checking each stud terminal to ground in the same way. If one stud terminal is dead, it may still jump a gap at the electrode tips; however, it may not be hot enough for igniting the fuel. This has fooled many service technicians that do not have a tool for checking transformers.

7.26 CHECKING FOR WATER IN THE NOZZLE DISCHARGE SPRAY

1. Since the oil spray is black, it is hard to detect water in the spray by sight.
2. **WARNING:** Disconnect the transformer wires so there is no spark at the electrodes.
3. Hold a mirror in front of the nozzle and start the burner, spraying oil onto the mirror.
4. Inspect the mirror. The oil will stick to the mirror and the water will bead up and run down to the bottom of the mirror.

7.27 CHECKING FOR WATER IN THE OIL SUPPLY

In a warm environment, the water in waste oil will settle to the bottom of the tank. Waste oil can have up to 2% water by volume that will not settle out. It is very common to drain one cup of clear water out of the bottom of a 250 gallon storage tank every week.

Waste oil with very little colloidal water in it is very black. As it takes on water, it turns very black to black-brownish. More water turns it into brownish color to eventually a gray whipping cream consistency. If you take a little of the brownish oil on a wooden stick and strike a match under it, it will burn with a sputtering flame. Fortunately, water and sludge settle to the bottom of the tank; that is the reason to put the oil pick-up tube a foot off the bottom of the storage tank. There are additives that can be mixed with waste oils to help settle the water quicker. However, any additives are an extra expense, and in time the water that is in waste oil will settle out by itself in a warm environment.

7.28 CHECKING FOR WATER IN THE AIR SUPPLY

If your air piping runs downhill to your burner, you will get water from condensation in your airlines. If your air compressor is not drained periodically, you will get water built up to a point where it will pass into your burner. If you disconnect the airline and let it blast into the palm of your hand, this expansion of air has a cooling effect and you will feel the moisture in the compressed air condense in your hand. Drain your tank and lines and install a desiccant-type air trap to collect water. Water mist or moisture in the atomizing air will make your furnace a nightmare to keep running properly. Typically, the wet air, contaminated with compressor oil and debris, will cook on the air pre-heater, then the residue will flake off and clog your nozzle, forcing you to clean the nozzle every continuously.

7.29 CHECKING THE NEON INDICATING LIGHTS

1. Use a multi-tester or a test light and determine if current is at the lamp. If it is, the lamp is burnt out, replace it. Note: The lamp cannot be checked with an ohm meter, current is required to check for operation.
2. If there is no current to the lamp, check the wiring and correct the problem.
3. If the lamps flicker or are dim, replace them as they are ready to fail.

7.30 JUMPING SWITCHES TO CHECK COMPONENTS – CAUTION: *ELECTRICAL WIRES ARE HIGH VOLTAGE; PROCEED WITH CAUTION*

It makes good common sense to use a short jumper to check many electrical switches and controls. However, do not bypass and leave the jumper on, as this is a dangerous practice. The following switches can be jumped to ascertain if they are malfunctioning or defective:

1. Air pressure switch.
2. Oil primary (black to the orange wires).
3. Fan control switch and hi-limit control.
4. Wall thermostat connections T-T on the primary.

TO TEST THE ELECTRONIC IGNITOR:

1. Disconnect the power to the oil burner.

2. Take the ignitor off the burner chassis so you can see the high voltage terminals.
3. Clean the porcelain insulators around the high voltage terminals. Check for signs of cracking or crazing, which is a series of fine cracks in the porcelain.
4. Disconnect the power to the motor so that no oil will spray into the combustion chamber while you are checking the spark generator.
5. Turn the power on and energize the primary control. You may have to disconnect one of the cad cell leads to get the primary control to start. Be careful, the ignitor is alive with the power on and can give you a nasty sting if you touch one of the high voltage terminals.
6. Using a well-insulated, dry screwdriver blade, touch one of the high voltage terminals and then extend the blade across to the other high voltage terminal. A strong, active spark should appear as you get close to the second terminal. Stretch the spark by moving the screwdriver away from the second terminal. The spark has to be at least 3/4" long.
7. Another method of testing an electronic spark generator is with an Ohmmeter. Disconnect the wiring to the ignitor and test each high voltage terminal to the burner chassis. You should get a reading of less than 2,000 ohms. The other terminal should give you the same, or close to the same reading. The terminal-to-terminal resistance should be twice the individual terminal resistance. If the terminal to chassis resistance differs by more than 10%, the spark generator should be replaced.

8.00 TROUBLE SHOOTING THE HEATWAVE FURNACE (see Kagi manual for additional information)

8.01 SEVEN COMMON REASONS WHY THE BURNER WILL NOT IGNITE:

- **IGNITION**
 1. No spark
 2. Bad electrode adjustment
 3. Partially or totally shorted spark
 4. Weak spark (bad transformer)
- **TEMPERATURE**
 1. Waste oil is not heated to the proper ignition temperature. (Is the preheater switch on?)
 2. Atomization air is cold and not being heated to the proper temperature
- **NOZZLE SPRAY**
 1. Nozzle plugged
 2. Nozzle spraying off pattern, debris restriction, defective nozzle
 3. Nozzle spraying but fuel flow is inadequate
- **IMPROPER ADJUSTMENT OF**
 1. Secondary air (blast tube air)

2. Oil pressure regulator
 3. Air regulator (for atomization)
- FUEL
 1. Suction Leak in fuel piping.
 2. Too thick (high viscosity)
 3. Water, antifreeze, sludged oils in tank
 4. Non-combustible liquid or synthetic oils in tank
 - AIR FOR ATOMIZATION
 1. Heavy moisture or water in lines
 - FLOODED CHAMBER
 1. Caused by oil impingement (defective nozzle, missing spinner in nozzle)
 2. Improper retention head position or angle of blades
 3. Oil is too cold, excessive oil pressure
 4. Burnt oil heater

Failure of ignition means that one or more of the above conditions are present. Do not attempt to perform major repairs on your furnace. See the HEATWAVE warranty. Call the KAGI Customer Service Department.

8.02 FLOODED FURNACE

If your HEATWAVE furnace has been flooded with excessive fuel, the excess must be removed. Refer to the section in this owner's manual on dust cleaning for instructions on gaining access to the combustion chamber. Even with proper clean out, there may be a thick coating of residual oil on the inside of the combustion chamber. When the burner is fired up, this thick oil will heat and turn into a grayish vapor as it tries to burn. Due to the rich mixture and lack of oxygen, your furnace will smoke and rumble. Do not be concerned as this residue must be heated and burned off. Sometimes turning the oil pressure down or off while the burner is rumbling will help. When a furnace is rumbling, it is starving for oxygen.

If you get a flameout, **DO NOT PUSH THE RESET BUTTON. YOU MAY CAUSE AN EXPLOSION – IF YOU PUSH THE RESET BUTTON WHILE THE GRAYISH VAPOR IS RISING.** Wait until the vapor has cleared. It can be observed through the barometric damper or outside smokestack. When the furnace is cool to the touch and the grayish vapor is no longer rising, push the reset button and refire the burner. You must refire the furnace and heat this thick oil to force it to vaporize. After a few attempts, the furnace will be cleared, the extra fuel burned off, and the rumbling will cease.

FOR HEATING TECHNICIANS ONLY

For the first few seconds after a flooded furnace is started, the furnace will not rumble and will operate normally. As the thick residual oil starts to heat in the chamber, the

furnace will rumble. Turn the oil regulator off immediately and continue secondary air to support combustion. Jumping the “F-F” terminals on the oil primary control will allow the burner fan motor to continue turning, pushing secondary air into the chamber to help burn residual oil and cool the chamber.

When flame-out occurs, DO NOT PUSH THE RESET BUTTON UNTIL THE FURNACE IS COOL TO THE TOUCH.

Remember, jumping the oil primary will pump oil into the chamber. *It is therefore, important to turn the oil off beforehand.* Disconnect jumper from the FF terminal when finished.

8.03 BURNER TROUBLE SHOOTING

If the burner does not ignite after pushing the reset button, unburned fuel is being sprayed into the combustion chamber. Repeatedly pushing the reset button will flood the unit. A time delay is built into the oil primary and is the reason for the 30 to 90 second wait before the reset button can be pressed. This delay is engineered into the product. It is not a defect. If the reset shuts off, it is probably a result of one or more of the following conditions:

1. No flame
2. Flame is weak or flame cone is dirty resulting in insufficient light intensity to activate cad cell.
3. Dirty cad cell lens; defective or inoperative cad cell
4. Defective oil primary control

Usually, if the burner fires up and the reset button pops out, the cad cell is dirty. Clean the cad properly, put a jump wire across the FF terminals (See Figure #11). If the burner continues to burn, the cad cell may be defective. Remove the cad cell and check it with the continuity tester. It should be open. Expose cad cell eye to open light. It should move to full continuity. If there is not a reading present, the cad cell may be defective. The cad cell must have at less than 700 ohms running, sensing light from the flame but if it reads over 900 ohms, it may be defective. Call the KAGI Customer Service Department for assistance. The cad cell assembly is not expensive, so if there is any doubt to its condition, replace it to be sure you will have no problems.

Next check the oil primary. Obtain a ½ watt ohm resistor from a local hardware or electronics store. Remove the cad cell wires on the oil primary and hook up the resistor (See Figure #10). Attempt to start the heater. If the heater starts, the oil primary may be defective. Disconnect one lead on the resistor. The oil burner should start up and the flame should ignite. If the oil primary is functional, it should shut off within 15 to 45 seconds, depending on the model of the oil primary. Before the oil primary shuts off, hook the loose lead back up to the resistor. The oil burner should continue to burn and operate. If the oil primary then shuts off, it may be defective. Call the KAGI Customer Service Department for assistance.

If the oil primary shuts off with the resistor attached to both FF terminals, it may be defective. **Do not open up the primary control and bend, adjust the relay bars or springs or anything in the primary control. It was sealed and preset for safety at the factory. Instead, call for assistance.**

8.04 FURNACE FAILS TO START

If your furnace fails to start and you have determined that the burner is turning on but there is no ignition, you must, by a series of elimination's, find out if the problem is caused by lack of ignition or fuel. Looking into the observation port, you will see a black mist coming from the nozzle if the nozzle is discharging oil. You must bear in mind that even if oil is being sprayed out of the nozzle, ignition will NOT occur if any of the following conditions is present:

1. Oil preheater switch is turned off for burning waste oil.
2. There is water in the oil spray mist.
3. The oil is NOT combustible.
4. The oil is not up to ignition temperature. (Green lamp must be on!)
5. The oil is spraying to the side (defective nozzle or debris in nozzle cap).
6. The oil flow is restricted (not enough oil). This is a common occurrence that baffles most service people. The burner must have a certain amount of spray, as if it is too lean, ignition will not occur. This is very similar to an automobile carburetor where, if the idle mixture is too lean, even if fuel is entering the manifold the engine will die.

If there is no oil coming out of the nozzle, start from the pump and work up to the nozzle to determine why you are not getting oil. Start from the pump and check the oil pressure there, and continue to the oil filters and determine if they are clogged. If there is no adequate oil flow or not oil flow at all, check the following and make sure that:

1. Air pressure switch is not malfunctioning, and there is adequate air pressure to the switch (must have approximately 9 PSI or higher to close).
2. Air proving switch is not malfunctioning and that it is closing (the air-proving switch senses the combustion air). NOTE: Some models do not have an air proving switch.
3. Oil regulator is set for proper flow pressure and is functioning properly.
4. Oil in your storage tank is adequate.
5. Oil solenoid valve has current and is functioning and not stuck shut.
6. Discharge nozzle is not obstructed.

After checking the above, determine why you are not getting oil or an inadequate flow of oil, and remedy the problem.

After you have corrected the oil flow problem, if you are still NOT GETTING IGNITION, place a small amount of newspaper through the observation port into the

combustion chamber in front of the nozzle and light it. Next, start the furnace, and if ignition occurs and the furnace keeps burning, you should conclude that the fuel is combustible and the ignition spark is weak, shorted out, or not there.

If the burner operates normally until the paper is burnt out, it is reasonable to conclude that the fuel has a high water content even if spark is present. Once ignition occurs in the burner, sparking of the electrodes is not necessary. Remember that on the standard KAGI burner, the spark is always arcing while the burner is operating. If the burner continues to burn when the paper is burnt away, and will not ignite on its own, the fuel is high in colloidal water or the spark is there but not hot enough for ignition. You must ascertain what the problem is. Also look for a restricted defective nozzle, or for obstruction in the fuel delivery system. Looking at a mirror placed inside the observation port to examine the spark is helpful. However, it may be sparking at the electrodes, or leaking to ground at the rear of the electrodes from cracks or carbon tracks.

CAUTION: (HIGH VOLTAGE CAN BE DANGEROUS; PROCEED WITH CAUTION)

Flip the transformer upside down and connect a jumper cable from each buzz bar to each electrode and with the oil regulator turned off, turn the burner on and watch for electrical leaks. Determine whether the spark is weak or not there. Look in index under “Checking the Transformer”.

8.05 FURNACE STARTS, BURNS A SHORT TIME AND THEN SHUTS DOWN

1. Listen to the nozzle discharging fuel. It makes a whistle and the loudness of this whistle varies with the discharge of oil. By turning the oil pressure up and down, you can hear this whistle. Familiarize yourself with the whistle and you will be able to determine by sound if the nozzle is restricted. If there is a spurting uneven noise, check for water in the fuel lines. When observed from the inspection port, the flame should reveal an uninterrupted spray of oil.
2. If the flame appears normal in length and characteristics, take a jumper cable and restart the burner first, and then jump the cad cell wires on the oil primary. These are the FF terminals on the oil primary control.

NOTE: Do not install the jump cables first, as the burner will not start.

NOTE: There is no danger from electrical shock as the circuitry is 24 volts on the oil primary FF terminals. If the burner continues to operate normally without interruptions, the cad cell lens is either dirty or defective. Clean the cad cell first and check; replace it if defective. See manual on checking cad cell.

3. If, after jumping the cad cell, the burner operates normally and then still shuts down, check the oil primary control. You can check the oil primary electronically later, but first try the oil primary control. You can check the oil primary electronically later, but first try this simple test:
 - Disconnect the power to the furnace at the main breaker. CAUTION: The electrical components inside the burner are 110 volts; safeguard yourself from electrical shock. Bypass the oil primary control. The current enters the

primary through a black wire and comes out as a hot orange wire. The third wire (white) is ground or common. Unfasten the screw that holds cover hinge down, and lift up the cover, exposing the preheater block and wire terminal junction. The underside of the oil primary and its three wires are exposed. Follow the black and orange wires to the wire terminal strip and connect a jumper across the two terminals, which will bypass the oil primary. Replace the cover to original position, turn the power to the furnace “ON”, and if the burner continues to run, your oil primary is defective.

CAUTION: Do not operate burner with this jumper on as it is bypassing the safety switch.

WARNING: THIS PROCEDURE IS FOR TESTING PURPOSES ONLY!

4. If the burner still stops, the power to the oil primary circuit maybe interrupted. With the jumper to the primary on the black and orange wires bypassed, check obvious things such as fuses in the control panel, loose wire connectors in the power source, and check all terminal screws on the aluminum block wire terminals for tightness. If all things checkout at this point, trace the wiring back to the Hi-Limit control. There maybe a loose connection there or the Hi-Limit switch is defective. For checking purposes, you can jump the wires to bypass the Hi-Limit micro switch. If it checks badly, replace this switch. Study the wiring schematic and start from the power “IN” lines ending at the burner. After you understand the wiring schematic, you will find it easy to trace and locate the problem.

8.06 FURNACE BURNS WITH A SMOKEY FLAME

Check all the following adjustment: secondary air, air pressure, and oil pressure. Check the draft and see if the chimney is restricted. A smoky flame indicates too much oil or not enough combustion air or both.

Check the nozzle and see if the oil distributor inside the cap was lost or unseated. Check the combustion blower for proper movement of air. If the motor is hot, the motor may not be turning at the proper speed. Check the blower cage for obstruction such as a rag or a piece of paper. Last, check the set screw on the combustion blower cage. It may be loose and spinning on its shaft. See Index of Drawings for illustration.

8.07 FURNACE BURNS WITH A LONG NARROW FLAME AND HITS THE TARGET

If the flame is too long and doesn't seem hot and the furnace is not over firing, the temperature of the oil is to low. The flame should be roaring, noisy, and bushy when the temperature is proper, if one took a hot normally burning flame, and gradually turned the oil temperature down a little at a time, the flame would decrease in diameter, becoming smaller and smaller until it hits the target where it would drip and burn smoky and lazily on the target wall. Check the oil cartridge heater and the air cartridge heater for

continuity, they both should be closed. There is also a possibility that someone has dumped too thick of oil in your storage tank and the oil heater is not heating the oil to proper atomization temperature. Check the nozzle, as someone may have dropped the small oil distributor out of the nozzle assembly. A smaller orifice nozzle with higher oil and air pressure may help atomize your problem oil. See Index of Drawings for illustration. (Figure #12)

8.08 FURNACE BURNS AND THE FLAME HAS SPARKS AND FIREFLIES

Many of the sparks and fireflies are due to colloidal aluminum, iron, and magnesium metal particles in the oil. This is due to the extremely hot flame of burning waste oil, which is oxidizing these metals. This is what makes fireworks glitter. The fireflies can be from glowing burning large particles of oil, indicating a bad nozzle which is not atomizing the oil properly or waste oil not at proper burning temperature. In waste oil furnaces, changing the nozzle usually will eliminate fireflies. Do not confuse oil impingement with fireflies.

8.09 FURNACE BURNS BUT HAS FLAME IMPINGEMENT: OIL SPLATTERS ON SIDES OF COMBUSTION CHAMBER AND FLAME IS LAZY AND SOOTY

If the oil is splattering straight ahead, off the target wall, check first and see if the retention head blades are plugged up. Waste oil is heated to break the oil into microscopic droplets. Heavier larger droplets of oil are spun together by the retention head for a complete burn. If the blades are coked up it cannot accomplish this. Remove the retention head and clean.

Certain multi-grade oils will cause splattering of oil on the target. Changing to a smaller orifice nozzle and stepping up the oil pressure will cure this problem. Before you change nozzles, check the preheater block temperature and ascertain proper temperature. Do not exceed 160° F. Cold oil burning away from the flame area looks like fireflies. Treat this as poor combustion of the fuel.

WARNING: The temperature should be at 160° F. Check the oil heater element and see if it is burnt out (see figure 42). If the oil is not at the proper temperature, the droplets will be large and be thrown on the target for an afterburn.

If the oil is splattering on the sides of the chamber and burning sooty, check the nozzle for proper discharge angle. You may have a defective nozzle. Replace with a new one. If the retention head is not positioned in the right location, you will have oil impingement on the sides of the chamber. The retention head is secured with a metal screw and when this screw is removed, the unit can be slid forward and back. Using the face of the nozzle as a position to work from, first move the retention head back from its original position and check the impingement. Slide the retention head back and forth, experimenting on the optimum location for minimum impingement. The blades on the retention head can also be altered to minimize impingement. These blades can be bent and opened up to

create a thrust of air more forward than the sides. These blades can be easily adjusted with a pair of duckbill pliers.

8.10 FURNACE BURNS WITH A SHORT FLAME

1. You should be able to lengthen the flame by increasing the oil pressure and readjusting the oil pressure, check the bypass pressure at the pump. It should be a minimum of 40 PSI. If pressure is low at the pump, start by adjusting the pump pressure higher and follow by cleaning everything in the fuel delivery system. You will have to start from the suction strainer, to the oil filters, the oil regulator, and the oil solenoid, and finally to the nozzle.
2. Remove the nozzle and check for obstruction. On new installations, check for proper nozzle size.
3. Check the rubber “O-ring” on the removed nozzle (figure 12). Leakage here will cause the air pressure to blow back the oil flow.
4. If checking these above things still fails to give you a proper length flame, you have overlooked an obstruction in the oil delivery system. Please, recheck everything, starting from the nozzle back to your oil supply and you should find the cause.

8.11 FLAME PULSATES

Flame pulsation is caused by one or a combination of the following. Check, repair, and adjust as necessary.

1. Air leaks in the suction side of the pump. First, tighten all connections, paying particular attention to the seal on the oil filters.
2. Debris in the oil or air regulator. Remove either regulator and clean.
3. Water or moisture in the air lines.
4. Combustion chamber has leaks. Check for cracks in the combustion chamber; inspect the dust covers for warping and the door gaskets for air leaks.
5. Check for adequate draft with a draft gauge. With furnace operating, setting should be .04 to .06 inches W.C.
6. Check burner motor and combustion cage blower. Be sure set screw is tight on the shaft. The blower cage may be loose and spinning on its shaft.
7. Check the rubber “O” ring on the nozzle for cracks, scratches, or cuts that will cause leaks.
8. Replace defective nozzle. Bad nozzles will pulsate the flame.
9. Check wire connectors to electrical solenoids for on and off interruptions.
10. Check solenoids by removing snap ring from solenoid spool coil and turning on the burner and gently pulling on the solenoid coil to see if the solenoid is magnetic. Replace if weak or questionable.
11. Nozzle holder nipple is loose and sucking air from the nipple threads.

8.12 FLAME PULSATES NOW AND THEN, ESPECIALLY WHEN IT’S WINDY, AND SOMETIMES GOES OUT

When there is back draft down your chimney, the flag switch (on models with one) will momentarily flop up and down, interrupting the air solenoid, causing erratic flame fluctuations. When this problem persists, it will kick your oil primary off, causing a shutdown of your burner. Usually this is caused by not enough draft from insufficient vertical chimney. If you don't have sufficient draft, you must install more outside chimney. If you had a qualified heating mechanic install your furnace and enough chimney was used, your building roof design, and/or location, is causing this problem. You might try installing a special cap for windy situations. These are the spinning exhaust caps or sail caps that turn away from the wind. The final answer, though expensive, is an installation of a power draft inducer.

8.13 FURNACE BURNS, BUT PUTS OUT LOW HEAT

If the color and flame length is correct, and the furnace seems to put out poor heat, note that the type of fuel you are burning will determine BTU output. Thin #1 or #2 furnace fuels do not put out as much heat as the thicker waste oil. Check the barometric damper, and correct the draft, if it over .08" of W.C. Excessive draft will chase your heat up the chimney. Check the secondary air or combustion air. An excessive flow of free air will lower heat output and drive the heat up and out the chimney.

Look in your manual on how to properly adjust the combustion air. You may have selected a furnace undersized to your heat loss. If you have a large space with an extremely high ceiling, with no ceiling fans, you may need more furnaces to compensate for heat loss. Before you blame the HEATWAVE furnace, make a simple test and measure the temperature of the air coming into your furnace circulation blower, then measure the temperature on the plenum output side. The temperature rise should be approximately 80° to 100° F. If it is not within these limits, the furnace is not burning properly. Go through the basic adjustments again and determine why it is not burning properly and correct the problem.

The stack temperature should be approximately 475° F. If the stack temperature is around 750° or higher, clean the dust out of the flue tubes and chamber. This dust acts as an insulator of heat and will cause this heat energy to escape up the chimney, not out into the room. It is the same principal as a limed-up car radiator. The lime inside the radiator blocks the conduction of heat to the fins of the radiator. If the sensible heat (TD temperature) is around 90° F., your HEATWAVE furnace is performing normally. The TD temperature is a formula heating mechanics use to calculate proper movement of the air and temperature rise. The constants of the formula are: the cubic feet per minute the blower moves, the BTU output per hour capacity of the furnace, and the temperature in and out of the furnace circulation blower. Do not condemn your HEATWAVE furnace if the temperature rise is within these figures. You can adjust an acetylene-oxygen torch to burn clean and extremely hot, in excess of 2500° F., but it isn't going to warm up your shop.

Cold air is denser than warm air. If your shop air is 50° F. or cooler, the air movement will be stronger, blowing a larger mass of colder dense air. As the room air rises in

temperature, it becomes thinner and less dense, moving less air through the heat exchangers, making the output air warmer.

8.14 FLAME IS TOO SHORT AND GETS SHORTER WHEN INCREASING AIR PRESSURE, AND THEN GOES OUT

When a longer flame cannot be established by increasing the oil flow and by adjusting the air pressure higher burning rate, the little rubber “O” ring on the discharge nozzle may not be holding, and is leaking. If this O-ring is cut or collapsed, the outgoing airflow (which sucks the oil out from the center of the nozzle) neutralizes this suction and diminishes the oil flow. If the oil ring is bad enough, increasing the air pressure will force the oil backward toward its source. When replacing the o-ring, take the stem, Fig. #2 drawing in the back of the book and with the head and distributor off, push it into the orifice, which the o-ring fits into, and check for tightness. It should be very snug. If it is loose and leakage is feared, install a larger diameter “O”-ring. If the bore has a sharp edge on it, and it is cutting the o-ring, take an oversize drill bit and hand scrape this edge slightly to dull it. Always put a little Vaseline or grease on this o-ring to protect it as it is inserted.

8.15 FLAME IS HARD TO ADJUST (A little turn and it is too much; a touch backward and it's too small).

This is usually caused by too high oil pressures your fuel pump is sending to your burner and/or excessive end play from a leaking or malfunctioning oil regulator. Also burning thinner fuel oils such as #2 furnace fuels and using a smaller inside diameter fuel piping than what is recommended on the pressure side of the pump. There is an adjustment built into all pumps to lower or raise oil pump bypass pressures. However, if it cannot be lowered to the factory recommended pressures, the bypass spring must be replaced. See Section 8.35, “Pump Bypass Pressure Too High.”

8.16 FLAME WILL CONTINUE WHEN THE INSPECTION DOOR IS OPEN; (BUT GOES OUT WHEN IT IS CLOSED).

This situation is usually due to inadequate draft caused by clogged flue tubes in the furnace cabinet, restricted chimney (improper cap, bird nests, and sooty chimney), back draft from wind or not enough chimney. Opening the inspection port merely admits more combustion air to support burning. Examine section 8.12 on proper chimney installation.

8.17 FURNACE BURNS TOO HOT

If your furnace is burning too hot, check for the following:

1. Defective air blower system from slipping belt, squirrel cage slipping on shaft, seizing tight blower motor, clogged blades.
2. Defective fan control.
3. Thermostat calibration is wrong or thermostat is in bad location.

4. Burner is being over-fired or separation baffle burnt out.
5. Fan limit temperature setting is off. Settings: 90° Fan Off, 115° Fan On, 170° High limit, burner power off.

If the circulation air from the blower is restricted or diminished, the cabinet air temperature will rise very quickly. Should the burner be in an over firing mode the same will happen. The blower will come on at the temperature set on the fan switch, which is part of the Hi-Limit switch. If the fan/on temperature setting is set higher than factory recommendation, the furnace will operate hot until the fan comes on. The Hi-Limit control will automatically kick the burner off should the air jacket temperature exceed 200° F. Understanding the controls and their functions will help you correct your furnace adjustments so your furnace operates safely, giving comfortable heat.

8.18 FURNACE DOESN'T SHUT OFF

If the burner keeps running after you turn the wall thermostat below room temperature, disconnect one wire from the TT terminal on the primary control. If the burner stops, the thermostat wires are crimped together somewhere and making continuity. Next, connect the wires back again on the primary control and disconnect the wires at the wall thermostat. If the burner still starts, this means the wires are shorted together. If the burner does not start when the wires are off at the wall thermostat, check the wall thermostat. The thermostat should indicate “open” when it is turned below room temperature. Replace it if it's bad.

8.19 FURNACE RUNS WELL, THEN THE BURNER STOPS AND THE BLOWER BLOWS COLD AIR

The burner receives it's current from the Hi-Limit switch so in case the air temperature in the cabinet runs too high from a blower failure, over-firing, or a blocked heat plenum, it can shut the power off to the burner. One can tell as the red and green indicating lamps will be off. The Hi-Limit switch could be defective or set too low. Inspect the setting. It should be set at 200° F. If the Hi-Limit switch stops current to the burner and the cabinet temperature is low, the switch is bad. Check the air around the sensor, if it is 170° F. or lower, we can assume the fan-limit switch is bad. Replace with a new one.

Be aware that the Hi-Limit control has the fan on one circuit, with an independent circuit on the Hi-Limit safety. It should be easy to determine when the fan should come on and off.

8.20 FURNACE BURNS BUT RUMBLES

When the furnace rumbles, it is an indication the furnace is starving for oxygen. Observe the flame through the observation door (CAUTION! DOOR AND KNOB MAYBE HOT!!): Open this door slowly and with face turned away. The flame is probably sooty from low oxygen. Go through the adjustments again; keeping in mind the rumbling is caused by lack of oxygen. If the flame appears normal, push open the barometric damper

and see if the noise gets louder. If there is poor draft over the fire, opening the damper of the barometric control exacerbates the problem. You probably are experiencing poor draft and extra chimney should be installed. The furnace may operate normally on some days without rumbling, but a cloud cover could change the draft through the burner.

If your furnace has been flooded or there is residual oil in the furnace chamber, it will rumble until the oil is burnt off. If this is a frequent problem, check the nozzle for oil dripping after the burner cycles off and repair it if necessary. See Index for “Nozzle Dripping”.

8.21 FURNACE OPERATES, BUT SMELLS

The odor from a new unit is nothing to be alarmed about. Over-spray and oils on the chamber will vaporize from heat and give off an odor. This will soon burn off. If however, the furnace was operating normally and then creates an odor, check the following:

1. Check for oil leaks that could be dripping onto the hot chamber.
2. Check for leaks in the chamber dust cover doors. When the cabinet blower comes on, in the right location, it could blow exhaust into the room.

NOTE: IF THE COMBUSTION CHAMBER SHOULD DEVELOP A LEAK, THE CABINET AIR PRESSURE IS GREATER THAN THE CHAMBER PRESSURE WHICH IS OPERATING AT A NEGATIVE DRAFT AND WILL FORCE THE EXHAUST IN, NOT OUT OF THE CHAMBER AND INTO THE ROOM.

3. Check for excessive dust in the furnace and flue pipes.

8.22 FURNACE DRIPS OIL

Check to see where the oil is coming from and tighten fittings, connections, etc., and secure the leak.

The furnace has a built-in 5° tilt on the burner blast tube so if the burner is up and the furnace is downhill, any condensation of oil vapor will drip into the chamber. If the burner is somewhat higher than the chamber and not generally level that is permissible, as the purpose of a level furnace is to ensure the blast tube has the proper tilt down to the chamber.

If the furnace operated satisfactorily for a while in the past and then begins dripping oil, first check the dust build-up in the flue tubes. Next, check the retention head for clogging. The oil spray may be bouncing back from the plugged retention cap and condensing. Check for clinkers that may have developed in front of the spray nozzle. Remember, that an uncleaned furnace with poor draft will cause the oil spray to come backward, condense, and drip oil. Keep your furnace clean at all times.

8.23 FURNACE IS SET AT NIGHT BUT IS OFF BY MORNING

The main difference between day and night furnace operations is the ambient temperature is usually lower at night and lower temperatures change operating conditions. For one thing, when the room temperature is set a little lower at night, this will make the oil in the lines colder and thicker. If the suction piping has a small leak, it will magnify this problem when the oil gets colder. Try setting the wall thermostat higher for one night, similar to your day setting, to see if someone is tampering with the air supply or electrical. Many times, someone is turning the wall thermostat off. The oil preheater must warm up for at least 15 minutes before the furnace is turned on to call for heat.

If the furnace works properly when the thermostat is set high and fails when it is turned down at night, check the following:

1. Minute air leaks in the suction side of the pump piping. When the furnace is started in the morning, observe oil pressure indicated on the oil pump. If you don't have an oil pressure gauge at the pump, install one for these tests. I strongly recommend installing a vacuum and pressure gauge at the pump permanently for diagnosing and service maintenance. When the furnace is started in the morning, observe immediately what the indicated pressure is. A delay will cause the primary to kick off. There should be instant pressure at the pump at all times when the pump starts. Open the bleed valves on the transfer pump and ascertain if air is in the lines. A small amount of air will parade up the lines, gradually working up to the burner, causing an annoying shutdown. Don't forget to question the oil pump. It may not leak oil however, it can have a vacuum leak in the shaft. Read section on "How to Check the Oil Pump Properly".
2. Check the oil heater element to see if it's open. If burnt out, replace.
3. Check the rubber "o-ring" on the nozzle and replace it if it is leaking.
4. Check the aluminum preheater block and see if its temperature is about 160° F. Check with an accurate pyrometer. If you don't have a pyrometer, set the temperature slightly higher, at 145° F. to check your furnace.

If what was checked shows that the furnace operates well during the entire day, we can then conclude at night the oil viscosity increases due to colder temperatures, and this is related to the shutdowns. Since setting the room temperature down at night will delay the intervals at which the pump and furnace operate, a small air leak in the suction side of the fuel delivery system could cause the oil to settle down from gravity and create an air lock. The gritty debris in waste oil prevents a good seal in any check valve, causing the oil to drain down by gravity.

5. Check the possibility of a severe downdraft at night from winds, and correct this with a suitable chimney cap. Read section 8.12 "Flame Pulsates" in this manual.

8.24 FURNACE HAS EXCESSIVE ASH BUILD UP

The residue from complete burning of waste oil should be a yellowish-gray ash. It should be dry and not caked up. If the residue is black and wet, and there are clinkers, there has not been a complete burn, as carbon unites with oxygen to form carbon dioxide, a gas. Go through your adjustments so the flame is burning clean, hot, and bright. You may unknowingly have contaminants in your oil that don't burn; they will leave a strange residue. Waste crankcase oils burn clean with a minimum of residue.

The type of ash buildup depends on the type of oil you are burning, and the length of time you operate your furnace. The interval between clean-outs may be too long. Generally, the heavier the oil, the higher the contaminants.

8.25 FURNACE HAS BLACK CLINKERS IN CHAMBER

Generally, carbon in the chamber means an incomplete burn. Read the section in this manual on "Excessive Ash", and check the dust buildup in the flue tube of the furnace. Check the draft before and after cleaning. A restricted flue tube means a cut in draft and a poor draft will result in bad combustion. The velocity is needed in the chamber for a good burn, and a poor draft will cause a sooty, smoky flame that will build up a residue.

8.26 FURNACE CHAMBER IS FLAKING METAL

If your chamber is flaking metal, you are over-firing your furnace. The waste oil flame is very hot, in excess of 2300° F., which can oxidize steel. See "Over-firing Your Furnace" or "Proper Flame Length", in this manual. If your furnace is located in a wet or damp area, a little rust is normal. However, excessive rust should be brushed and treated with heat resistant stove black.

8.27 FLAME IS NOT BURNING IN THE CENTER OF THE BAFFLE TARGET; See Section 8.28

8.28 FURNACE BAFFLE HAS BURNOUT HOLE OR IS LOOSE AND NOT IN RIGHT POSITION

The flame is purposely engineered to not burn in the center of the baffle target. The reason is, if the baffle is ever burnt through, it can be removed and turned 180° F. and reinstalled. Should the welds or bolts break so that the baffle is not in its proper position, stop using the furnace; remove the baffle and correct the problem. A baffle in the wrong position could restrict or deflect the hot exhaust draft and cause premature combustion chamber failure. Hot exhaust deflected improperly can destroy the baffle that separates the primary and secondary flue tubes, causing dangerously high stack temperatures. HEATWAVE may replace this baffle with a heavy ceramic baffle in the future after testing for reliability.

If you are experiencing premature baffle deterioration, you are over-firing your furnace or burning contaminated waste oils that are high in chlorides. (Chlorides are from certain petroleum cleaning solvents.)

8.29 OIL PRIMARY TROUBLE SHOOTING

- **PROBLEM**

The oil burner fires up, but the oil primary control reset kicks off.

NOTE: The oil primary control is designed to kick off in 15 to 45 seconds if the burner does not fire up.

- **HOW TO DIAGNOSE AND CHECK THE OIL PRIMARY CONTROL**

The oil primary control is the gray box with the red reset button on the top of the oil burner. The cad cell or “electric eye” is the round device, with dimensions of approximately ½” x 2”, with two yellow wire leads connecting it to the FF terminals on the oil primary control. STUDY SECTION 7.16 “OIL PRIMARY TEST”. See Figure #11.

8.30 OIL OR AIR SOLENOIDS CHATTER

CAUTION: When working on any part of the electrical system on the burner, cut off the power to the furnace from the main breaker pane to avoid electrical shocks. Most of the electrical is 110 volts A.C. and dangerous. As a second check to assure yourself the power is off, push the plastic button on the fan control switch in. The blower should NOT come on. If the blower comes on, you were not successful in turning the main current off to the furnace.

Turn the flat slots on the brass body of the valve counterclockwise and take the valve body apart. Clean the piston, checking to see that it moves easily in the bore. Be sure the piston is replaced with the rubber disk down and ensure the spring is in the rear of the solenoid piston. Spray WD 40 to lubricate it and do not over tighten the valve stem when reassembling the valve. Turn the current back on, and see if the chattering has stopped. If it hasn't, shut the current off again and try lifting the spool up and down to see if the noise stops. If it does stop the chatter, remove the spool and put some thick silicon heatproof grease between the spool and body. In some cases, you will have to install a dielectric thin plastic shim. The chattering should stop; otherwise, replace with a new solenoid.

8.31 OIL REGULATOR IS NOISY (HUMS)

If you are burning thinner oils such as #2 furnace fuels, your regulator may make an annoying hum or noise. Try adding thicker waste oil to stop this hum. If you have run out of waste oil and none is available, drop the oil bypass pressure at the pump. This usually takes care of the problem. In most cases, the oil pump is factory set to bypass at 40 PSIS; however, you probably do not need this much pressure. You need enough pressure to overcome the fluid flow resistance in the lines and all the restrictions that are in the burner. All you need technically is slightly more oil pressure than what the regulator is set at. In most cases less than 3 PSI. Check the up and down end play of the oil regulator stem. If it is excessive, this does not mean the regulator is defective.

Replace it with a different one that does not have as much end play if you wish to stop the noise. If you have used smaller ID lines to fuel your furnace than what HEATWAVE recommends, this will exacerbate your problem. Correct it, and do it right.

8.32 PUMP DOES NOT WORK WHEN BURNER COMES ON

1. Check the electrical first, making sure the power is coming to the pump motor. If you are not getting current, check all the wire connecting nuts for tightness. This current comes from the air pressure switch located under the lid of the primary control. Chase it down. You may have a loose terminal screw. Jump the two wires on the air pressure switch. If the pump comes on, the switch is defective or out of adjustment.
2. If the pump is turning but not working, check the rotation of the motor, it may be turning in the wrong direction. Most furnace manufacturers buy these motors and it is possible to receive one turning in the wrong direction. It is very simple to change the polarity and get it turning the other direction.
3. If the motor is turning and the pump is not working, check the set screw on the shaft for tightness if you are using this type of a coupler. If you are using a plastic coupler, check that the end caps are not snapped apart or that the internal teeth of the caps are rounded out internally. In time, if the end caps jump off or the teeth are gone, there would be noise.
4. If there is a serious air leak on the suction side of the pump, it will not work, as it is not self-priming. To check the pump to see if it could be defective, disconnect the intake port and feed oil directly into it, using a rubber hose and holding the end of the rubber hose uphill. Take the discharge line off and turn the pump on and open the bleeder valve on the pump till oil spurts out. The pump should shoot oil out from the discharge port. Or check by putting a little oil in the intake port of the pump and place your thumb to cover the intake hole; it should strongly suck your thumb.
5. If you suspect the pump is defective and sucking in air, remove the pump and plug the discharge side of the pump and pressurize the intake with approximately 50 PSI air pressure. Submerge the pump in clear kerosene to observe bubbles. If the bubbles are coming from the cover, replace the gasket. If the bubbles are coming from the pump shaft, replace the pump. See section 7.23 “Checking the Oil Pump Properly”.

8.33 PUMP OPERATES WELL, BUT IS EXCESSIVELY HOT

It is perfectly normal for the pump to run warm to hot, depending on the thickness of the oil. Compressing anything will create heat. On the single-line system, (which is what HEATWAVE uses); the oil is compressed to the factory set bypass pressure to push the piston aside to internally bypass the built up pressure. This creation of heat actually helps the waste oil furnace, as waste oils become very thick and heavy when cold. The heat from the pump will heat up the oil for a better flow. How hot is too hot? You may not be able to keep your hand on the pump and that could be normal. Check the pump’s bypass pressure; it should be 40 PSI. Lowering this pressure will drop the temperature. The

pump could have a scored pump shaft and this could be binding, generating excessive heat. To check this, disconnect the pump from the motor shaft and turn by hand. It should turn freely without binding. If tight, replace the pump.

8.34 PUMP OPERATES BUT IS NOISY

1. Check the plastic, motor-to-pump coupler. It may be stripped internally or the caps could have snapped partially off.
2. Check the pump shaft for scoring.
3. Check if the pump motor is defective, transmitting the noise.
4. Check if the internal pump screen is plugged.
5. Check the vacuum on the pump and ascertain if the oil filters or suction strainers are plugged or restricted. (Pumps are noisy on high vacuum).
6. Check the oil pressure bypass at the pump and see it is not excessive. Check with the manufacturer as to what the bypass pressure of the pump you are using should be set at.

8.35 PUMP BYPASS PRESSURE TOO HIGH

To lower the bypass oil pressure of you remote oil pump to the recommended factory specifications is an easy task. There is a lock nut and adjusting screw generally opposite the discharge port. The adjusting screw may be hidden under a removable cap. Turning the adjusting screw compresses the inside spring and raises the pressure, which turning counterclockwise lengthens the spring and lowers the pressure. If you cannot lower the pressure to the factory specs, ***DO NOT CUT OR SHORTEN THIS SPRING***. If this spring is shortened beyond a point, your pump will not function. The piston opposite this spring must be in the bottom position to function. You must obtain and install the proper weaker spring. All pumps have a built-in adjustment screw to raise or lower the pressure, but to within a certain range, i.e., pump with a bypass at 40 PSI can be adjusted from 25 to 100 PSI.

If the oil pressure is too high, it will be difficult to adjust the flame. You will experience a situation where a very slight turn will be excessive, resulting in over firing or a slight turn backward and it's under firing. Too high an oil pressure and burning thinner viscosity oils such as #1 and #2 furnace fuels will exacerbate this problem. Installations where the fuel pressure line from the pump to the burner is smaller than recommended internal diameter will restrict the flow and also exacerbate the problem.

8.36 PUMP TURNS, BUT NO PRESSURE

On new installations check Section 4.00 of this manual. If the pump was working in the past and does not produce adequate pressure, check for fuel restrictions feeding the demand port on the pump. Start from the pump screens and work back to the oil in the storage tank. If all seems well, remove the pump, disassemble it, and examine the pump gears and faceplate. Check for excessive wear from abrasion. A metal gear pump cannot pump abrasive grit and last very long. If your oil has this uncommon property, switch to

a diaphragm-type trash pump. The KAGI technicians can assist with this type of problem.

8.37 PUMP HAS TOO MUCH VACUUM OR NO VACUUM

If your pump has too high a vacuum (exceeding 20" HG) you are overworking your pump. If the pump is located too high from the oil level, and the oil viscosity is thick and cold, your pump's life will be shortened and frequent heater shutdowns will occur, due to air locks from the fuel vaporizing inside the pipes. The simple fact is your piping has too much flow resistance. Check the inside diameter (ID) of the pipes that they are not too small for the load. A pump located on top of a storage tank will not have much vacuum load and piping as small as ½" ID instead of ¾" (on the suction side) copper can be used for this short a distance. However, longer distances will require larger ID pipes to lower the flow resistance. (See Index of Drawings for Piping Schematics). If the oil temperature is warm (70° F. or higher) and there is NO flow resistance to your pump, this is an ideal condition and your vacuum will be zero or next to zero. Whatever the vacuum is, mark the vacuum gauge with an ink pen after all filters and strainers are clean, and monitor the vacuum rise. A rise in the vacuum of five inches or more should indicate the cleaning necessary on your inline filtering messy job.

NOTE: Put a petcock on your vacuum gauge so the vacuum may be turned on or off for reading. Leaving a constant vacuum on any vacuum gauge in time will ruin any vacuum gauge.

8.38 PUMP WAS WORKING UNTIL THE OIL FILTER/SCREEN IN THE PUMP WAS CLEANED

If you are using a ¾" or larger ID suction fuel lines with single or dual filters, remember that it takes time to evacuate this large amount of air. The gears on most pumps are small and have a small displacement. Therefore, allow enough time for priming. Depending on the wear on your pump, the gears may have more clearance than when they were new and need a little help to be primed. Removing the filter/s and filling them and the lines is a must. Remove the intake line entering the pump and take an oil can and fill the cover cap with oil to help seal the gears. You may have to do this several times. If you did not install a "priming fill T" or check valves in the suction system, you will experience more difficulty to get the first prime. Make this checklist:

1. When you removed the screen and cover plate from your pump was a new gasket used? Is there a burr on the cover and pump surfaces so that the gasket is not sealing? (It doesn't take much of an air leak to cause trouble).
2. Did you reseal the joints in the suction piping with thread sealer? Do not use Teflon tape!
3. Are the oil filters and pipes full of oil? Did you put oil into the pump cover to aid priming the pump? **DID YOU OPEN THE BLEEDER VALVE? Your pump will not suck or prime unless you open this valve!**
4. Did anyone remove the bypass piston in the pump and install it backwards? It can fit backward, but it will not work. Did you install all the parts in the pump

properly? It the drive pin for the gears sheared off or missing? It is very small and will drop out.

5. Is the bypass adjustment screw, screwed out excessively? If it is past a certain point, the pump will not suck.

Read all the sections in the manual on pumps and “the correct way to check the pump.”

8.39 NO SPARK AT THE ELECTRODES

1. Check for shorted electrodes on the retention head.
2. Check for cracked insulators on the electrodes allowing spark to reach ground.
3. Check for sooted dirty porcelain at the rear of the electrodes that is grounding the spark.
4. Check for broken or shorted buzz bars at the rear of electrodes.
5. Check for loose wire nuts, loose wires on the circuit board, contact between the transformer high tension studs and buzz bars and the transformer circuitry. The transformer must have current to operate.
6. Check for weak or defective transformer. Check each transformer high-tension stud to ground. You may have lost one electrical leg of the transformer. It will spark between the electrodes, but it will not be hot enough for proper ignition.

8.40 NO OIL DISCHARGE AT NOZZLE

1. Check nozzle for debris that is restricting oil flow.
2. Check air proving switch for closing or malfunction. This switch is located under the transformer by the combustion blower wheel. Note: Your model burner may not have one.
3. Check the air pressure switch for closing. You must have at least 9 PSI of air pressure at the preheater block.
4. Check all oil solenoid for current and malfunction.
CAUTION: DO NOT TURN CURRENT ON WITHOUT ELECTRICAL SPOOL ON THE SOLENOID BODY, AS IT IS A DEAD SHORT AND WILL BURN UP IN SECONDS.
5. Check oil pump for pressure, inspecting to see if there is sufficient oil in the supply tank, obstruction in the oil piping, and/or improper oil pressure at the regulator.
6. Check oil regulator for malfunction. Disassemble the oil regulator; clean it first before labeling the regulator as defective.

8.42 NO OIL SPRAY FROM NOZZLE DUE TO A MALFUNCTIONING AIR PRESSURE SWITCH (Located under the hinged cover that the oil primary control sits on)

If your air pressure switch (located under the swing cover where the oil primary control is attached) is malfunctioning and it is a model where it interrupts the oil solenoid, it may be out of adjustment or malfunctioning. To determine if it is energizing the remote oil

pump or the oil solenoid, follow one of the wire leads and see if it connects to one of the oil solenoid wires. This is the standard wiring for the KAGI burner. The KAGI burner as standard wiring has the air pressure switch, only, and solely, energizing the oil transfer pump. To review the KAGI burner wiring, the oil solenoid is energized by the primary control, period. The air pressure switch energizes the oil pump and nothing else. In this way, an oil pump that is located far away from the burner or is forced to pump cold thick oil will not overload the primary control. Many oil burners tap the current for the pump from the primary control. Most primary controls are limited to 10 amps whereas the air pressure switches that KAGI manufacturing uses is rated at over 3 HP.

First, see if the air pressure at the gauge is over 9 PSI setting. If it's lower than 9 PSI, reset the regulator to at least 12 PSI and start the burner. If this does not remedy the problem, take the two leads attached to the air pressure switch and connect these two wires together. You are now bypassing the air pressure switch! Start your burner and see if you are getting oil spray out the nozzle. If this was the trouble, the air pressure switch may be out of adjustment. This switch is factory preset to close at approximately 9 PSI. It is therefore, very important that the air pressure setting at the burner is greater than 9 PSI. Too low a pressure to the burner will cause the points in this switch to open and shut off the oil flow. Find the tiny Allen inset screw on top of the switch and turn clockwise to close. Use the air pressure gauge to adjust to 9 PSI. If turning this adjustment screw does not remedy the problem, the switch is defective. Be sure to reconnect the wires to the two top spade connectors of this switch which has three spade connectors. Just use the top two connectors!

- DO NOT WIGGLE THE PUSH-ON CONNECTORS SIDE TO SIDE ON THE AIR PRESSURE SWITCH AS YOU WILL CRACK THE PLASTIC INSULATORS OF THIS SWITCH!
- DO NOT RETURN THIS SWITCH UNTIL YOU HAVE TRIED ADJUSTING IT, as 19 out of 20 switches returned are only out of adjustment.

CAUTION! DO NOT OPERATE THIS BURNER WITH THIS SAFETY SWITCH BYPASSED. IT IS INSTALLED IN YOUR BURNER AS A SAFETY DEVICE. IF THIS SWITCH IS DEFECTIVE, REPLACE IT WITH A NEW ONE.

8.43 BURNER HAS SPARK AND OIL SPRAY, BUT WILL NOT IGNITE

Study section 8.03 of this manual first, which discusses the problem of no ignition through the furnace was operating properly and then shutdown occurred. On new installations study the section of this manual dealing with pre-start.

8.44 BLOWER RUNS CONTINUOUSLY

On the fan control switch there is a small plastic button. This should be pulled out for automatic control. If this button is pushed in, the circulation blower will operate, regardless of the furnace cabinet temperature. This switch is sometimes called a "summer fan"; it allows air to be circulated from the furnace in warm weather. For heater use, this button should be pulled out for automatic control in the winter. Inside

this switch are two movable tabs that control when the blower comes on and when it goes off. Generally, the fan is set to come on at approximately 140° to 150° F., and turn off at 100° F. These “on” and “off” temperatures can be set at whatever the owner desires. Since normal human body temperature is 98° F., any air blowing in your face would seem cold if it were less than 100° F. Therefore, the blower is set at rest until the burner heats the cabinet air temperature to over 140°. However, if the room is extremely cold and the fan is cycling off too frequently because the room temperature is below 50° F., many furnace owners push this button in and leave it there until the ambient temperature comes up.

NOTE: Some fan controls may not have this summer fan feature.

If the above checks out okay, the fan control switch is defective. Remove and replace it.

8.45 FURNACE FAN CYCLES TOO OFTEN AND THE ROOM IS COLD

The circulation blower is set to come on when the air cabinet reaches 140° F. If the ambient temperature is below 50°, it will cool this switch and turn the blower off. Since normal body temperature is 98°, any air movement below this temperature would seem cold; this is the reason the blower turns off when the air temperature lowers to around 100°. As the room temperature rises, the cycling frequently lessens until the furnace can keep up with the temperature drop.

After ascertaining that the furnace is operating properly and efficiently, and room temperature is lower than you desire, your heat loss is greater than it was calculated to be. (If you feel your furnace is not performing optimally, look under “Furnace Operating but Putting Out Low Heat” in the Index.) A larger or extra furnace probably is needed. If you ceilings are high, you should install ceiling fans. If heat loss is from walls and ceilings, insulation should be installed. If temperature rise calculations of your furnace are within the range of 90° F., do not blame the furnace. You can’t expect your furnace to perform the miracle of giving off more heat than what is taken away by heat loss.

8.46 CONTINUOUS AIR FLOW OUT OF NOZZLE

If air continues to come out of the nozzle after the burner is shut down, check if there is current to the AIR SOLENOID. If current is there when the burner is off, it is wired incorrectly. Trace, using the wiring schematic, and correct. This valve is normally closed, and when current is introduced to it, it opens and allows the air flow. Check that the airflow is in the right direction on the valve. This valve could have been installed backwards. There is an arrow on the body of the valve pointing to the airflow direction. If it is backwards, the air pressure will push the piston up, and open the valve.

Check for debris under the rubber disk inside the solenoid body. Remove the piston from the air solenoid body and clean. Follow instructions from the section in this manual titled “Oil Solenoids”. See index and drawings on proper disassembling of the solenoid, figure 9. If the above procedure fails to correct the problem, replace the solenoid. Note: The air and oil solenoids are the same.

8.47 CONTINUOUS OIL FLOW FROM THE NOZZLE

Is current off to the oil solenoid when the burner is off? If current is there, the oil solenoid is wired wrong. Study wiring schematic and correct. This valve is normally closed, and when current is introduced to it, it opens and allows the oil to flow.

Check the oil flow and make certain that the valve is installed correctly. There is an arrow on the body of the valve pointing direction of flow; it should point in towards the aluminum block, or away from the oil regulator. If the valve is installed backwards, the oil pressure will force the piston up and the valve will leak. If the current is off and the valve is leaking, there may be debris under the rubber disk on the internal piston of the oil solenoid valve. Disassemble the oil solenoid valve with the help of the drawings and information under “Oil Solenoids”.

If the above fails to cure the problem, replace the solenoid valve.

8.48 FAULTY WALL THERMOSTAT

If the wall thermostat does not turn the furnace on, check the following:

1. Is the thermostat turned up higher than the room ambient temperature?
2. Does the reset on the primary need to be tripped?
3. Are the thermostat wires connected to the TT terminals on the primary?
4. Is there electrical continuity on both wires?
5. Is there power to the furnace?
6. Is there a fire from residual oil in the chamber?

If all of the above checks out and putting a jump cable across the TT terminals on the primary starts the burner, replace the wall thermostat.

If changing the setting on the wall thermostat doesn't seem to make a difference when the furnace turns on or off, replace the wall thermostat.

8.49 GREEN LIGHT COMES ON, THEN IT GOES OUT; AFTER A LITTLE WAIT, IT COMES ON AGAIN

The normally open temperature sensor (SNAP DISC) which turns the green neon lamp on closes at approximately 120° F. When it opens from cooling down, the green light goes out which is an indication that the aluminum oil preheater is cooling down. If the oil supply is extremely cold entering the burner, this can happen. It is best to correct this problem as oil should be at least 120° or higher for a good burn. You can correct this by heating your oil supply with heat tape or with proper approved tank heaters. Under certain conditions, and with permission, KAGI Heating Supplies and Manufacturing, Inc. can furnish special larger wattage heaters for your problem. Be sure to check with KAGI technicians before attempting any unauthorized field changes.

8.50 OIL PRESSURE GAUGE ON THE BURNER STARTS TO CLIMB WHEN THE BURNER SHUTS OFF AND GETS SO HIGH IT SOMETIMES RUINS THE GAUGE

If the indicated oil pressure on your oil burner operates normally but starts to climb and eventually breaks your gauge, it is caused by expanding cold oil. A slight rise in normal, as there is a shut-off valve built into your oil pump and your burner. The expanding oil in your lines cannot go backward toward your oil supply because your pump has a shut-off valve built internally and the burner shut-off solenoid is after the gauge.

The oil left in the pipes will have to expand and it has to go somewhere. This “T”, recommended earlier on the proper installation of the furnace, is for the fuel to be able to expand. It also allows easy oil priming of the system, and allows air to be in the system. Liquids cannot be squeezed, but air can be. This design system is also built into auto radiators, and cautions with instructions about leaving an air trap so the liquids can expand and squeeze the air pocket and not damage anything. Using a larger inside diameter pipe from your oil supply to your pump and burner will exacerbate the problem.

Common sense tells us if the oil coming into the building is cold and the building is warm, this will also exacerbate the problem. You will experience this problem where the oil source is far away from the pump and the burner. Many installations have a one-way check valve in the supply tank, and with this long run of oil, which is shut off at the burner and supply pump, this cold expanding oil will cause a problem. This is not a difficult situation to remedy.

THIS PROBLEM IS ONE OF THE REASONS TO INSTALL THE TOIL FILTERS SUPPLIED BY HEATWAVE ON THE SUCTION SIDE OF THE PIPING SYSTEM.

Should the pressure build up overnight and blow the rubber O-ring or break the oil filter, and if the oil filter is installed on the pressure side of the piping system, a start-up will allow the burner to operate, but it will leave a disastrous amount of waste oil on your floor. On the other hand, air leaking into an oil filter on the suction side will only cause an annoying burner shutdown. Because tiny minor air leaks from a cleaned oil filter or just about any air leaks from the suction side of the supply system are not forgiving, many installers place the filter on the pressure side. **HEATWAVE DOES NOT RECOMMEND OIL FILTERS TO BE INSTALLED ON THE PRESSURE SIDE!** Most rubber “O” ringed sealed oil filters are only safety certified by UL to 30 PSI! Also on the pressure side, many oil filters do not have a pressure relief valve. Added to that, how does one ascertain when the oil filter is dirty if it is on the pressure side? The filter on the vacuum side can be equipped with a vacuum gauge to ascertain when it is plugged up.

Use of heat tapes on the pipes works well. A certified tank-warming device may be the answer. On long runs a second storage tank vented to the atmosphere with a booster pump can solve this problem. A small bleed return line can also be installed. If you have a similar difficult situation and you need assistance after you have tried the various

solutions offered here, call the technicians at KAGI Heating Supplies and Manufacturing, Inc.

10.0 INDEX OF DRAWINGS

- Dimensional view of HW 150 (measurements)	Figure 1
- Dimensional view of HW 250 (measurements)	Figure 2
- Dimensional view of HW 350 (measurements)	Figure 3
- Dimensional view of HW 350 (continued)	Figure 4
- HeatWave Specifications	Figure 5
- Kagi Burner Drawing	Figure 6
- Furnace Installation Example	Figure 7
- Multi-Wall Chimney Installation	Figure 8
- Furnace Installation Example Drawing	Figure 9
- Floating Oil Pick-up (dirty tanks)	Figure 10
- Oil Primary Control	Figure 11
- Nozzle Exploded View	Figure 12
- Electrode Adjustment	Figure 13
- Air Regulator Exploded View	Figure 14
- Oil Regulator Exploded View	Figure 15
- Flame Characteristics	Figure 16
- Exploded view Air / Oil Solenoid	Figure 17
- Delta Pump	Figure 18
- Suntec J Pump	Figure 19
- Suntec 7740	Figure 20
- Webster M17DN Pump	Figure 21
- Webster 1RR14	Figure 22
- Pump / Motor Alignment	Figure 23
- Lenz Filter System	Figure 24
- Fan Belt Adjustment	Figure 25
- Breaker box	Figure 26
- Wiring Schematic	Figure 27
- Burner Wiring Diagram	Figure 28
- Wiring Burner Cord & Junction Box	Figure 29
- Honeywell Fan & Limit Control	Figure 30
- White-Rodgers Fan & Limit Control	Figure 31
- Terminal Strip Wiring	Figure 32
- Kagi Wiring - Drawing A	Figure 33
- Kagi Wiring - Drawing B	Figure 34
- Kagi Wiring - Drawing C	Figure 35
- Kagi Wiring - Drawing D	Figure 36
- Kagi Wiring - Drawing E	Figure 37
- Kagi Wiring - Drawing F	Figure 38
- Kagi Wiring - Drawing F (ICM)	Figure 39
- Kagi Wiring - Drawing F-1	Figure 40
- Kagi Wiring - Drawing F-2	Figure 41

- Air and Oil Pre-heaters	Figure 42
- Parts HW150/250	Figure 43
- Parts HW350	Figure 44
- HW Cleaning	Figure 45
- HW Cleaning (continued)	Figure 46
- Warning / Caution Decals	Figure 47
- Warning / Caution Decals (continued)	Figure 48
- Warning / Caution Decals (continued)	Figure 49

HEATWAVE

WARM IT UP WITH A FREE SOURCE OF HEAT!

MULTI-FUEL UNIT HEATERS



HW150 HW250 HW350

Siebring Manufacturing, Inc.

303 S. Main St. PO Box 658

George, IA. 51237

Ph. 712-475-3317

Fax 712-475-3490

www.siebringmfg.com

SECTION 1 - WARRANTY

1.1 KAGI WARRANTY. Kagi Heating Supplies & Manufacturing, Inc. (KHS) will warranty parts and labor to the consumer for a period of twelve months from the date of purchase. KHS warranties each burner sold will be free of defects in materials and workmanship under normal use and service for a period of one year. Date of purchase will be date received by the customer. See Kagi Burner manual for detailed warranty information.

1.2 HEATWAVE WARRANTY. HEATWAVE Warrants to the purchaser of this Multi-Oil Fueled Heater Unit that it will repair or replace any part which in normal use proves to be defective in material or workmanship within a period of ONE (1) YEAR from the date of purchase, provided same is returned for factory inspection and warranty determination. The combustion chamber (Limited Warranty) is warranted for a period of TEN (10) YEARS at a pro-rated schedule, provided the heater is properly installed and maintained.

HEATWAVE does not warrant the paint finish as this is subject to abrasion, scratching, and discoloration during installation and operation. The warranty does NOT cover any labor charges involved with parts replacement or service unless preauthorized by Siebring Mfg., Inc. in writing.

1.3 CONDITIONS THAT WILL VOID WARRANTY.

Using in the heater or adding to the storage tank substances, including, but not limited to the following: paint, thinner, gasoline, other volatile liquids, or solvents, transformer oils, or gear lubes. Some of these substances have a high chloride content which can oxidize HEATWAVE stainless steel targets and chambers. It is illegal to mix any of these substances with waste oil and doing so can cause a hazardous condition.

Tampering with internal components.

Not installing the heater properly as per instruction in this manual and/or according to local and state codes.

Not maintaining the heater according to instructions in this manual or by authorized personnel.

Any part altered or abused.

Using parts other than those supplied by Siebring Mfg., Inc. to operate this heater

Over-firing the unit.

Warranty is limited to the original purchaser only, and is void if moved from original site of installation.

SECTION 2 – GENERAL INFORMATION & HAZARDS

2.1 INTRODUCTION. The Heatwave heater by Siebring Mfg. provides the owner with a dependable, versatile and simple means of burning # 1 and # 2 fuel oils, 10W – 50W used crank case oils and used automatic transmission fluid. Maintained correctly, the heater will give years of service. Carefully read the owner’s manual before installing and using the unit. In the event there is a problem with your heater or the installation of your heater, contact your distributor for assistance.

2.2 DIMENSIONS. Dimensions are calculated without the burner.

Heatwave 150	65" x 35" x 39"H	Crated weight 700 lbs.	(see figure 1)
Heatwave 250	75" x 36" x 49"H	Crated weight 840 lbs.	(see figure 2)
Heatwave 350	60" x 36" x 82"H	Crated weight 1080 lbs.	(see figure 3)

2.3 FIRING CAPACITIES.

Heatwave 150	1.1 – 1.5 gallons per hour.
Heatwave 250	1.7 – 2.0 gallons per hour.
Heatwave 350	2.5 – 3.2 gallons per hour.

2.4 NON-RESIDENTIAL WARNING. This heater is for commercial and industrial use only. This unit is NOT rated for residential use.

2.5 ADHERANCE TO CODES. Installation of this unit is to be done in accordance with all state and local codes or authorized having jurisdiction over environmental control, fuel, fire and electrical safety.

2.6 APPLICABLE CODES FOR HEATER INSTALLATION. National Fire Protection Association (N.F.P.A.) codes for heater install.

- NFPA 30 Flammable and Combustion Liquids Code
- NFPA 31 Standards for the Installation of Oil-Burning Equipment Code
- NFPA 70 National Electrical Code
- NFPA 88A Standard for Parking Structures Code
- NFPA 88B Standard for Repair Garages Code
- NFPA 211 Standard for Chimneys, Fireplaces, Vents, and Solid Fuel-Burning Appliances

The above codes available from the National Fire Protection Association,
1 Batterymarch Park, Quincy, MA. USA 02169-7471 Tel. 617 770-3000 www.nfpa.org

2.7 INSTALLATION. This heater and systems must be installed by an experienced, qualified waste oil fired heater installer.

2.8 DUCTWORK. This heater is not designed for attachment or use with ductwork.

2.9 WARNING. Do not attempt to start the burner when excess oil, oil vapor or fumes have accumulated. To prevent backfire that could harm personnel or possibly damage the unit, NEVER press the reset on the primary control more than two times.

2.10 WARNING. Do not store gasoline or any other flammable liquids, or vapor producing materials near the heater.

2.11 WARNING. This heater is not designed for use in hazardous atmospheres such as: paint shops, feed mills, or any installations where explosive or flammable conditions are present or could occur.

2.12 WARNING. Heatwave heaters by Siebring Mfg. rely on a natural gravity draft. Down drafts (positive) pressures in the heater's chimney will occur in buildings where negative pressures are created by exhaust fans (car exhaust vents, spray booths, ventilation fans, etc.), Do not try to use a power vent to overcome a downdraft pressure. An adequate air make-up system is needed when exhaust fans are used.

SECTION 3 – HEATER INSTALLATION

3.1 Do not install heater on a combustible material of any kind.

3.2 Install heater in a location to utilize total heat throw.

3.3 Install heater in a location to permit a correct outdoor chimney exit to eliminate down drafts, provide easy chimney installation and maintenance.

3.4 Install the heater in a location to permit as close as possible fuel supply.

3.5 Do not install heater more than 10 feet above top of fuel tank (see page ?? Learn about special pump installations).

3.6 Before suspending the heater, check the supporting structure and reinforce if necessary to support the heater/system. See figure 4 for unit weights.

3.7 Minimum clearances to combustibles:

Top	6"	Chimneys	18"
Sides	18"	Rear	18"
Front	24"	Bottom	18"

3.8 Use threaded rod rated for applicable heater weight to suspend from a capable load carrying ceiling structure.

3.9 Heater should be installed level for proper operation. Heater installed “not level” could cause a hazardous situation in which personal injury or property damage could result.

3.10 When installing the heater, keep in mind that you must have reasonable access to the unit for servicing.

3.11 Installation Diagram Page:

- | | |
|------------------------------|-------------------------------|
| 1. Chimney Cap | 11. Electrical Service panel |
| 2. Class “A” insulated pipe | 12. Air Compressor (2.4 CFM+) |
| 3. Barometric Damper | 13. Pump with vacuum gauge |
| 4. Capped Chimney “Tee” | 14. Fill Pipe |
| 5. Draft Reading Port | 15. Water/sludge Drain |
| 6. Oil Regulator (on burner) | 16. Lenz Oil Filter |
| 7. Secondary Air Regulator | 17. Vent Pipe |
| 8. Burner | 18. Check Valve |
| 9. Room Thermostat | 19. Oil Pick-up Strainer |
| 10. Primary Air Regulator | 20. Supply Tank |

Notes:

-Do Not use compression fittings or unions on the suction side. Use flare fittings and threaded fittings with thread compound.

-Do Not use Teflon tape.

-Do Not use air lines that have an automatic oiler.

-If shop air is 125 PSI or lower, the primary air regulator (item 10) is not required. If shop air is 125 PSI or greater, install primary air regulator and adjust air to 125 PSI or below.

-A moisture/water trap must be installed in the air line prior to the burner.

-Some state/local codes may require the supply tank to be vented outside (item 17).

SECTION 4 – CHIMNEY INSTALLATION

- 4.1 Failure to provide proper venting of the heater exhaust gases could result in death, serious injury and/or property damage.
- 4.2 Safe operation of any gravity vented heating equipment requires a proper air make-up system to prevent heater exhaust gases from being drawn into the building which may cause death, serious injury and/or property damage.
- 4.3 Never vent this heater into another heater's chimney. This heater must have its own separate chimney.
- 4.4 Inspect and maintain the chimney and air make-up system regularly.
- 4.5 Install a U.L. listed barometric draft control in chimney. Do not reduce or enlarge the vent pipe.
- 4.6 To prevent drawing exhaust gases into the building, keep barometric draft control at least two feet from the heater, exhaust fans, etc.
- 4.7 Position draft control as shown in pages ??, gate hinge pins must be horizontal for proper operation.
- 4.8 Secure all chimney/piping connections with 3 screws/rivets per joint.
- 4.9 Chimney clearance to combustibles – 18 inches.
- 4.10 Do not install heat reclaimers, manual draft controls or any other type of restrictive controls in the chimney.
- 4.11 Install an 8" diameter steel vent "tee" with a cap (for clean out) at the transition of the chimney.
- 4.12 Use 8" inside diameter class A insulated chimney pipe to vent exhaust gases through walls, ceilings, attics, roofs, combustibles, etc. Consult state and local codes.
- 4.13 Vent chimney at least 3 feet above the roof and at least 3 feet higher than any portion of the building, roof or obstruction within 10 feet of the chimney.
- 4.14 Do not use a rotating chimney cap. Use a non-restrictive cap.
- 4.15 Chimney caps should be at least 4 inches above chimney exit.
- 4.16 The chimney must be capable of producing a negative $-.02 - .04$ W.C. draft when hot as measured between the heater and the draft control. Refer to section 5 "Draft." Refer to section 3 for typical chimney installation.

SECTION 5 – DRAFT

5. The chimney system connected to the Heatwave should have a negative $-.02 - .04$ W.C. draft when hot (minimum of 10 minute run time) as measured between the heater and the draft control.

SECTION 6 – FUEL SUPPLY TANK INSTALLATION

- 6.1 The fuel supply tank and supply line must be installed in accordance with the National Fire Protection Association requirements, state and local codes and ordinances.
- 6.2 Regulations require oil storage tanks located inside the building not to exceed 275 gallons individually and not to exceed 550 gallons in one building.
- 6.3 Locate fuel tank inside the building as close to the heater as possible. Not to exceed 25 feet to avoid oil flow problems.
- 6.4 If possible, pitch/position fuel tank with the drain valve at the lowest point to drain off water. Sludge may have to be removed manually.
- 6.5 Some areas may have special requirements for the fuel tank vent (exiting outdoors, above the roof line, etc,) check local codes and ordinances. Keep vent clear.

INDEX OF DRAWINGS

Dimensional view of HW 150 (measurements)	Figure	1
Dimensional view of HW 250 (measurements)	Figure	2
Dimensional view of HW 350 (measurements)	Figure	3
Dimensional view of HW 350 (continued)	Figure	4
HeatWave Specifications	Figure	5
Kagi Burner Drawing	Figure	6
Furnace Installation Example	Figure	7
Multi-Wall Chimney Installation	Figure	8
Furnace Installation Example Drawing	Figure	9
Floating Oil Pick-up (dirty tanks)	Figure	10
Oil Primary Control	Figure	11
Nozzle Exploded View	Figure	12
Electrode Adjustment	Figure	13
Air Regulator Exploded View	Figure	14
Oil Regulator Exploded View	Figure	15
Flame Characteristics	Figure	16
Exploded view Air / Oil Solenoid	Figure	17
Delta Pump	Figure	18
Suntec J Pump	Figure	19
Suntec 7740	Figure	20
Webster M17DN Pump	Figure	21
Webster 1RR14	Figure	22
Pump / Motor Alignment	Figure	23
Lenz Filter System	Figure	24
Fan Belt Adjustment	Figure	25
Breaker box	Figure	26
Wiring Schematic	Figure	27
Burner Wiring Diagram	Figure	28
Wiring Burner Cord & Junction Box	Figure	29
Honeywell Fan & Limit Control	Figure	30
White-Rodgers Fan & Limit Control	Figure	31
Terminal Strip Wiring	Figure	32
Kagi Wiring - Drawing A	Figure	33
Kagi Wiring - Drawing B	Figure	34
Kagi Wiring - Drawing C	Figure	35
Kagi Wiring - Drawing D	Figure	36
Kagi Wiring - Drawing E	Figure	37
Kagi Wiring - Drawing F	Figure	38
Kagi Wiring - Drawing F (ICM)	Figure	39
Kagi Wiring - Drawing F-1	Figure	40
Kagi Wiring - Drawing F-2	Figure	41
Air and Oil Pre-heaters	Figure	42
Parts HW150/250	Figure	43
Parts HW350	Figure	44
HW Cleaning	Figure	45
HW Cleaning (continued)	Figure	46
Warning / Caution Decals	Figure	47
Warning / Caution Decals (continued)	Figure	48
Warning / Caution Decals (continued)	Figure	49

HW150

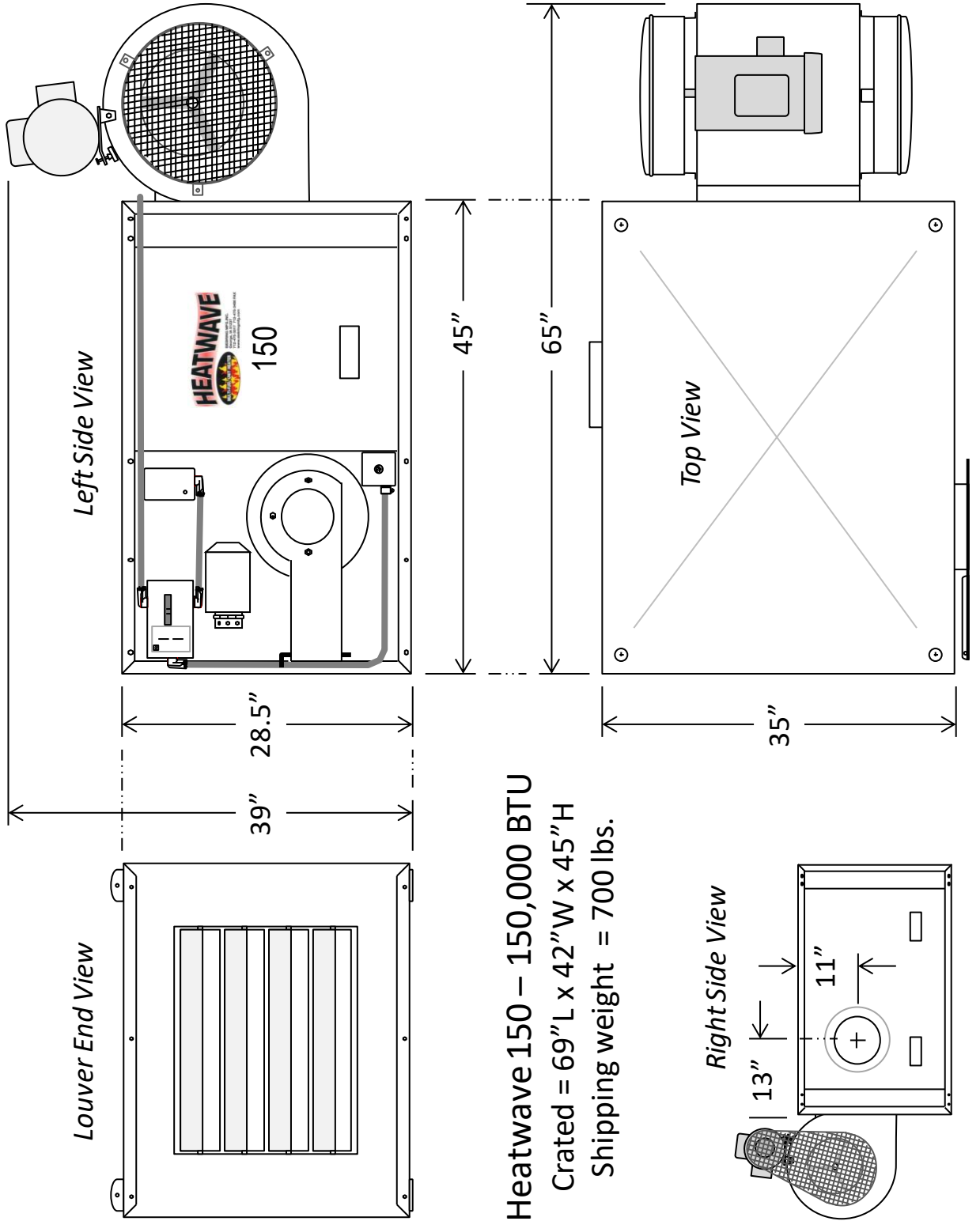

Heatwave 150 – 150,000 BTU
Crated = 69" L x 42"W x 45" H
Shipping weight = 700 lbs.

Figure 1

HW250

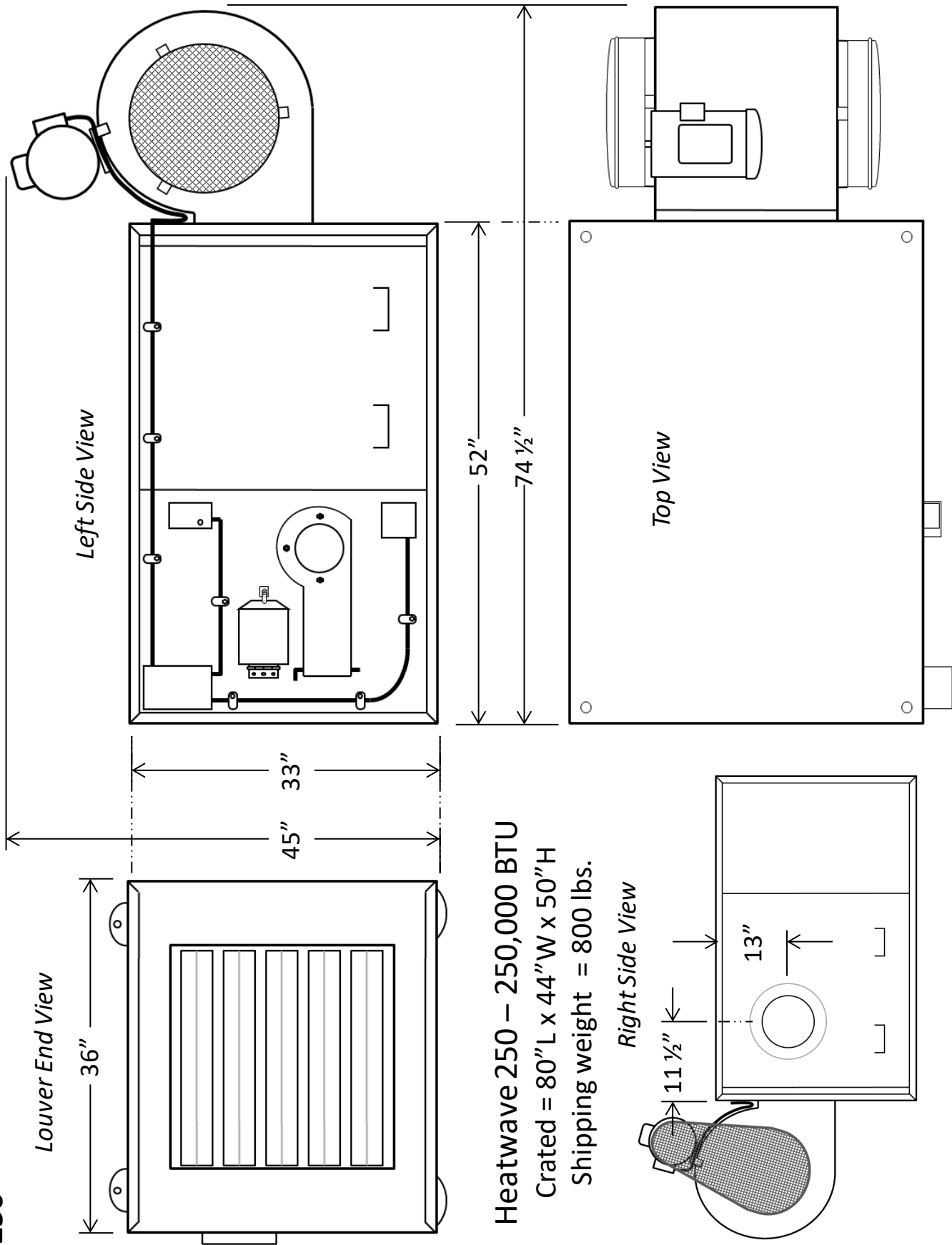

Figure 2

HW350

Heatwave 350 – 350,000 BTU
Crated = 68" L x 45" W x 85" H
Shipping weight = 1080 lbs.

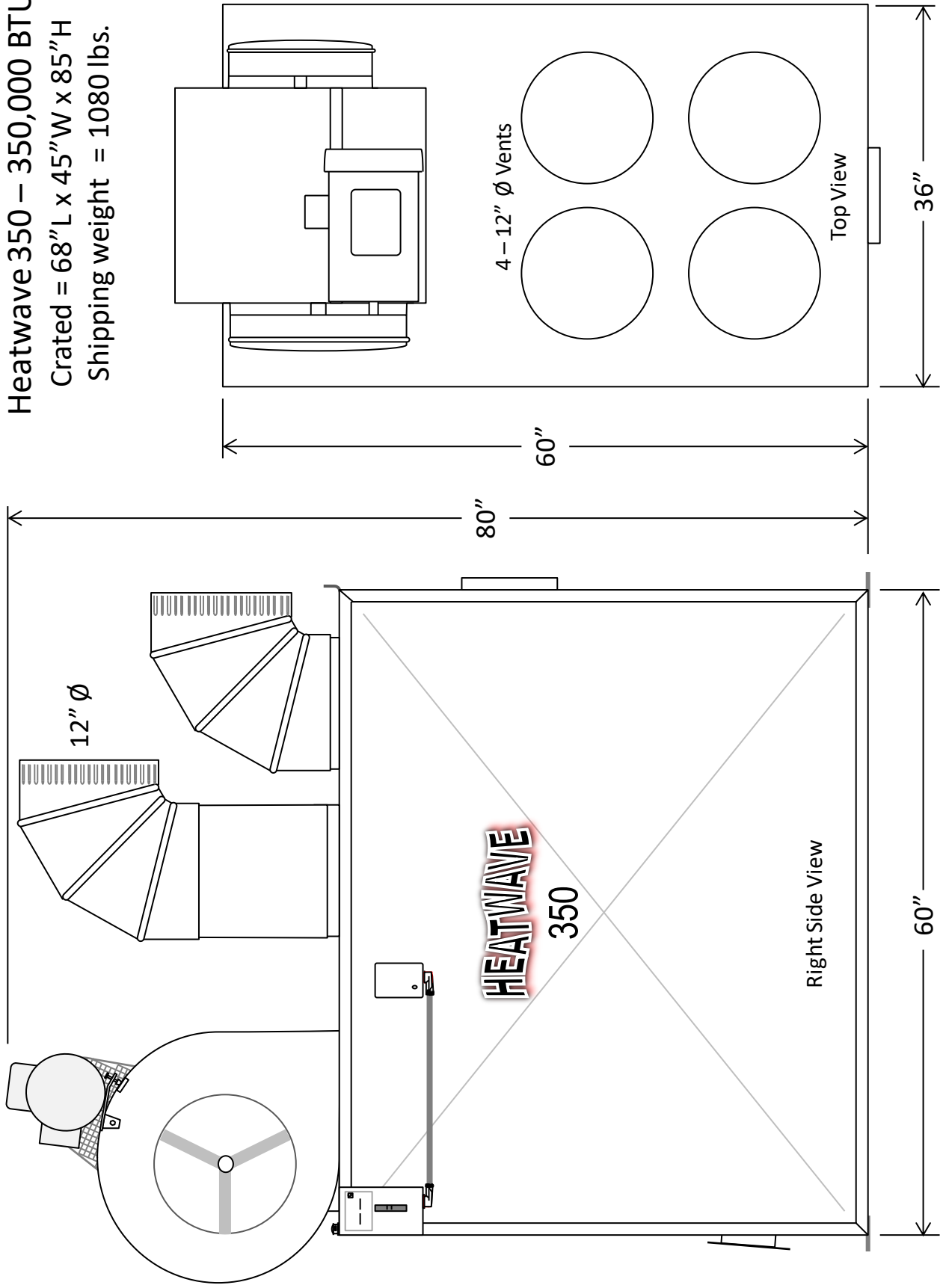

Figure 3

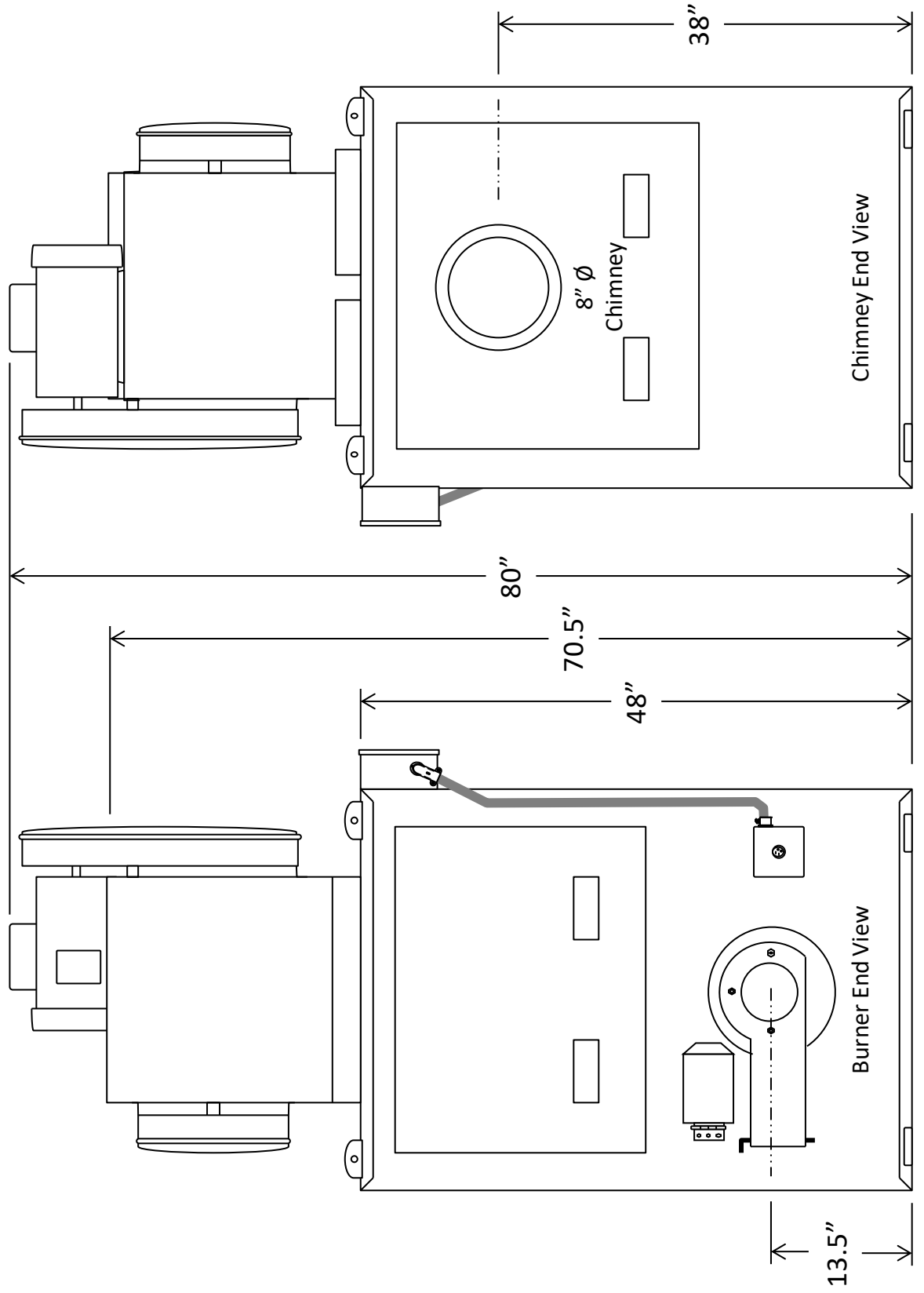

Figure 4

KAGI S250/500 WASTE OIL BURNER

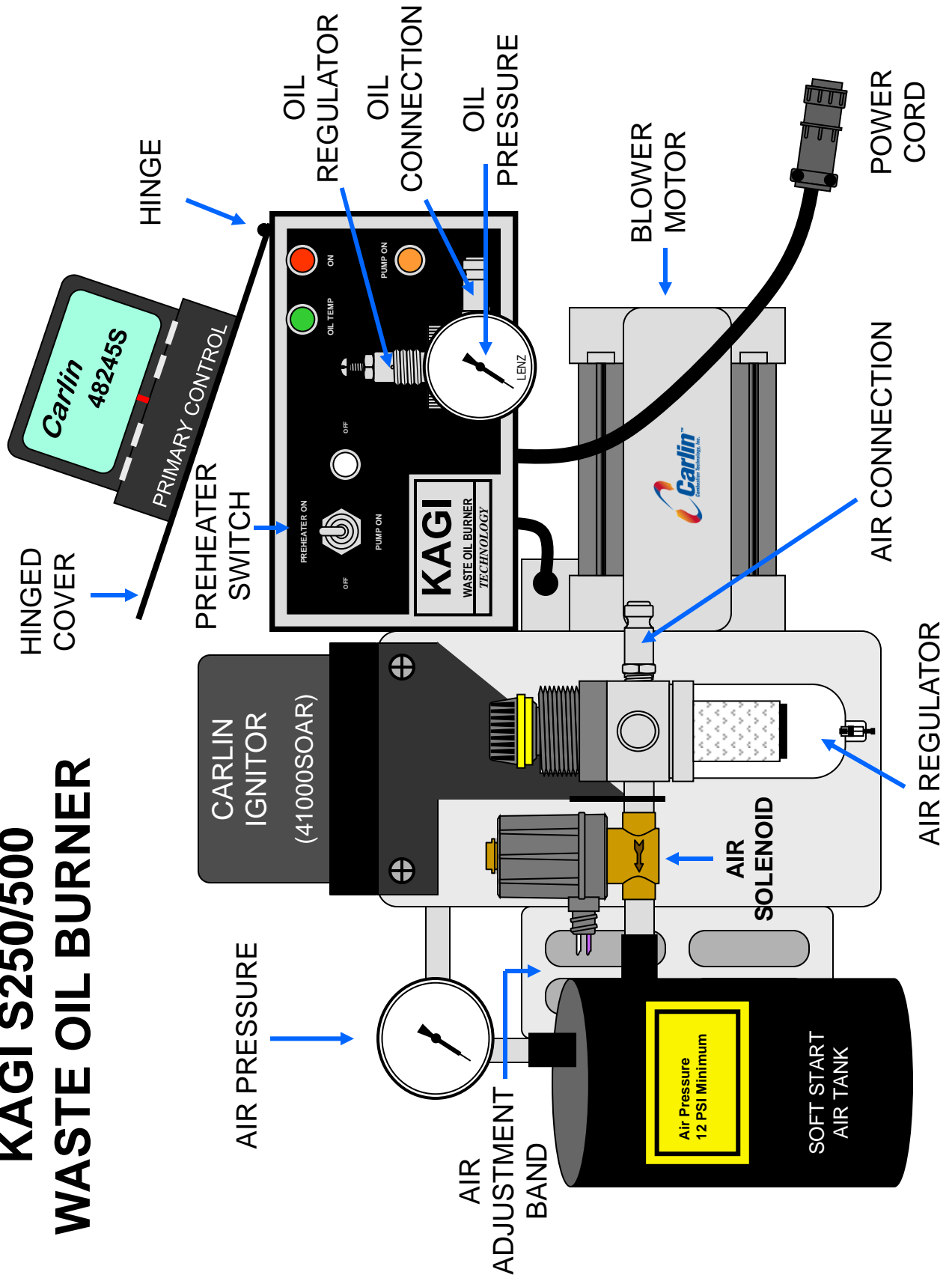
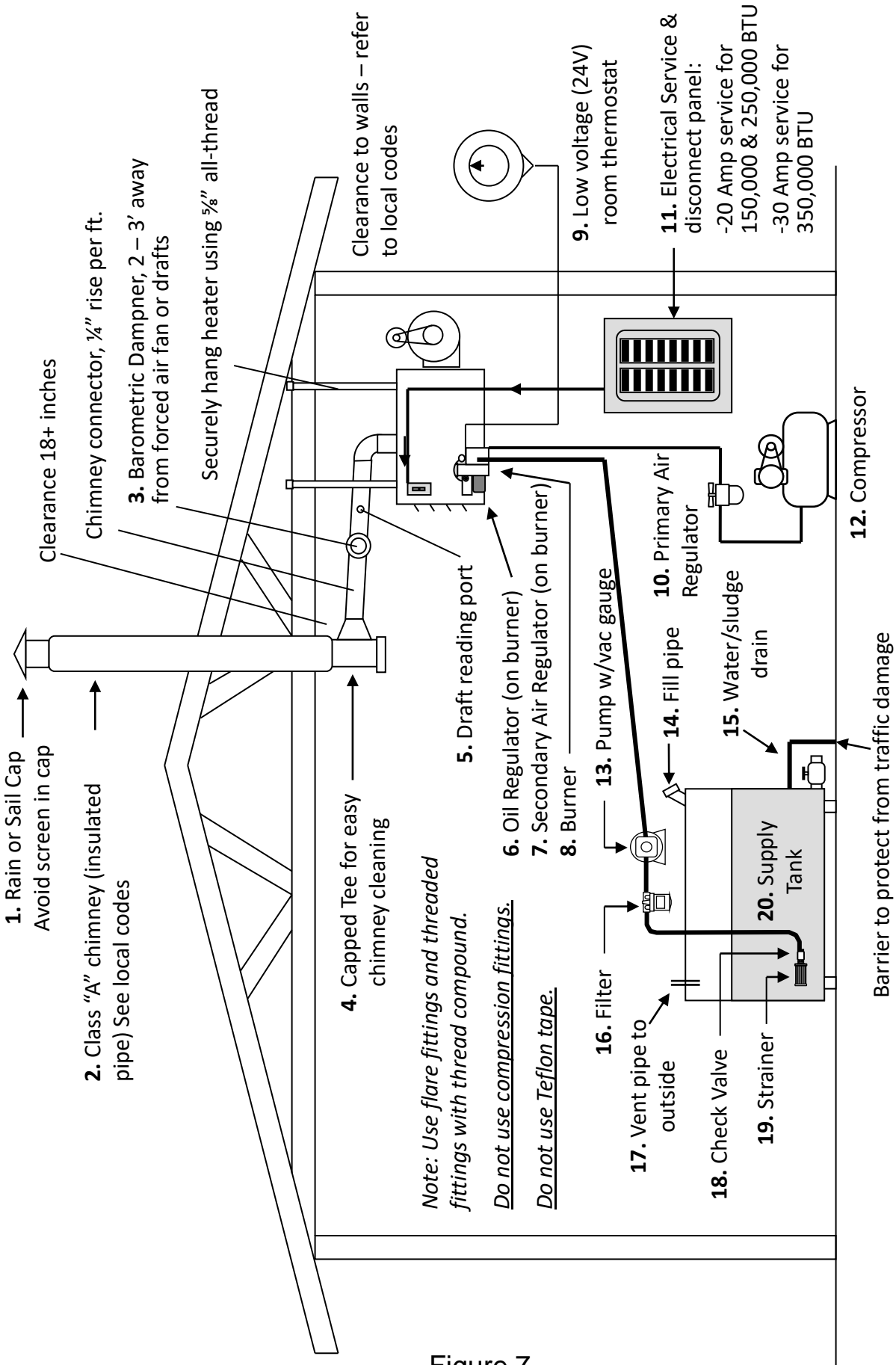

Figure 6



150,000/250,000 BTU Heater Installation Example

Figure 7

MULTIPLE WALL INSULATED CHIMNEY INSTALLATION

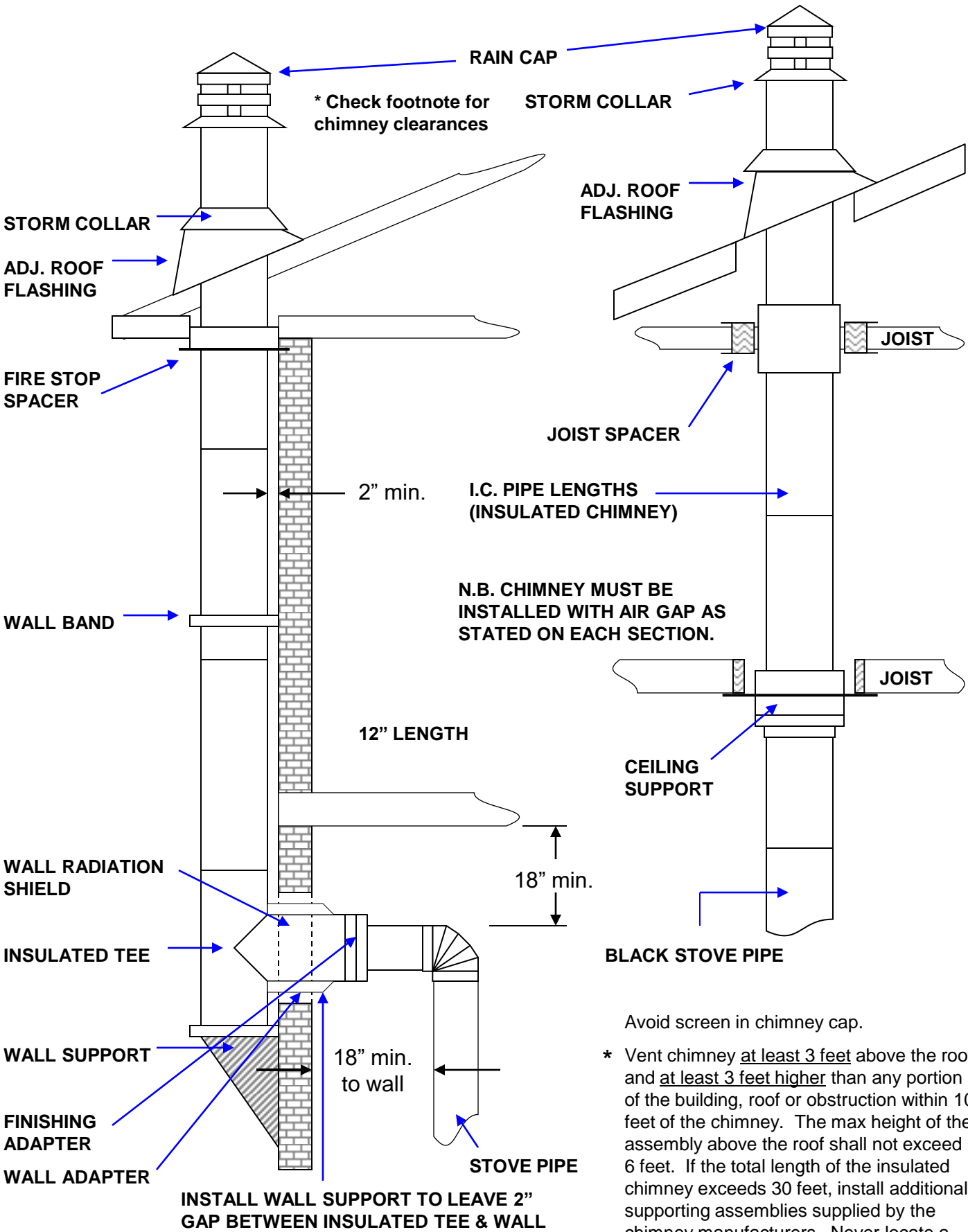

Avoid screen in chimney cap.

* Vent chimney at least 3 feet above the roof and at least 3 feet higher than any portion of the building, roof or obstruction within 10 feet of the chimney. The max height of the assembly above the roof shall not exceed 6 feet. If the total length of the insulated chimney exceeds 30 feet, install additional supporting assemblies supplied by the chimney manufacturers. Never locate a joint inside walls or in a joist spacer.

Figure 8

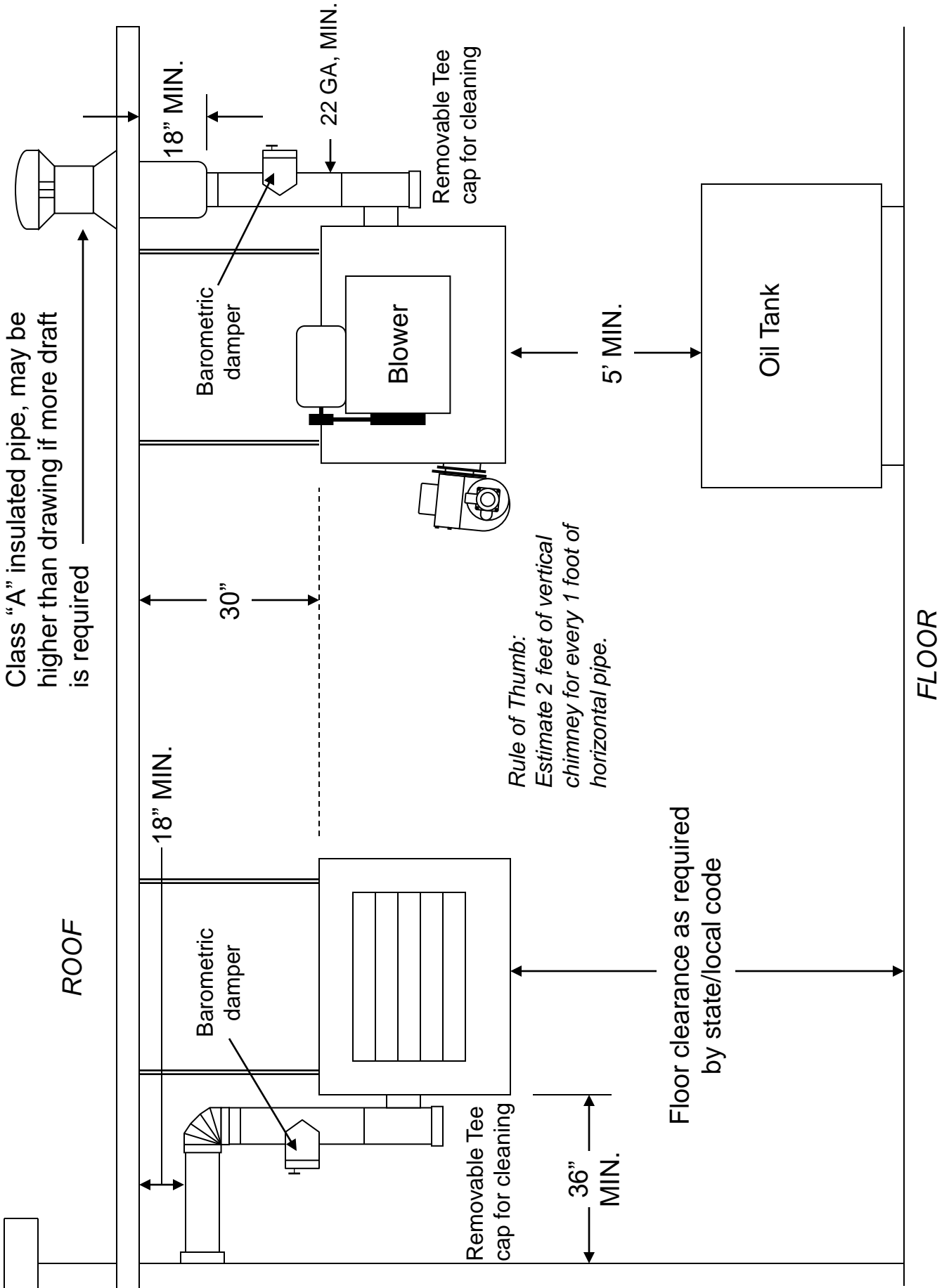

Figure 9

FLOATING PICKUP SUMP FOR DIRTY STORAGE TANKS

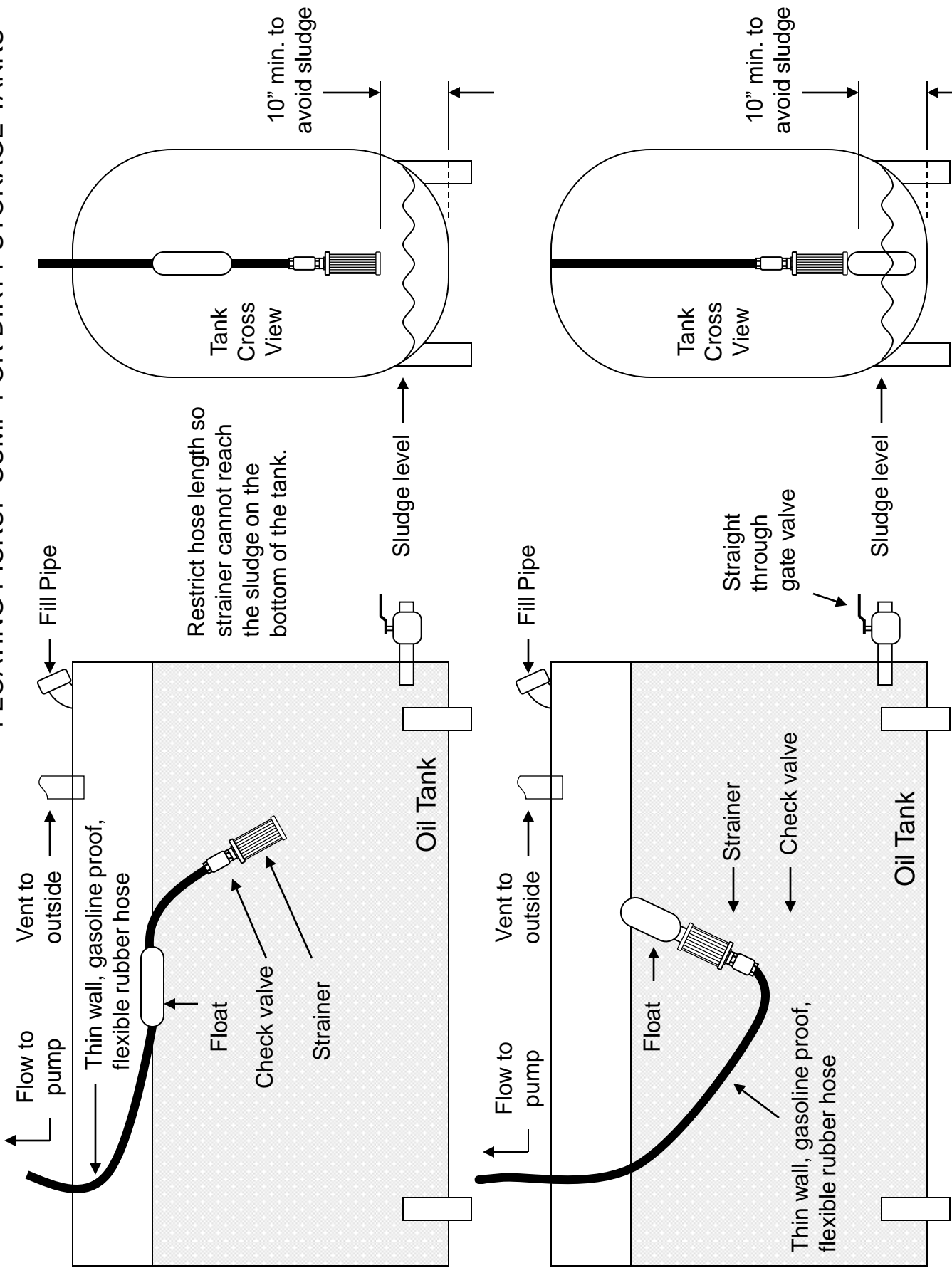

Figure 10

Oil Primary Control

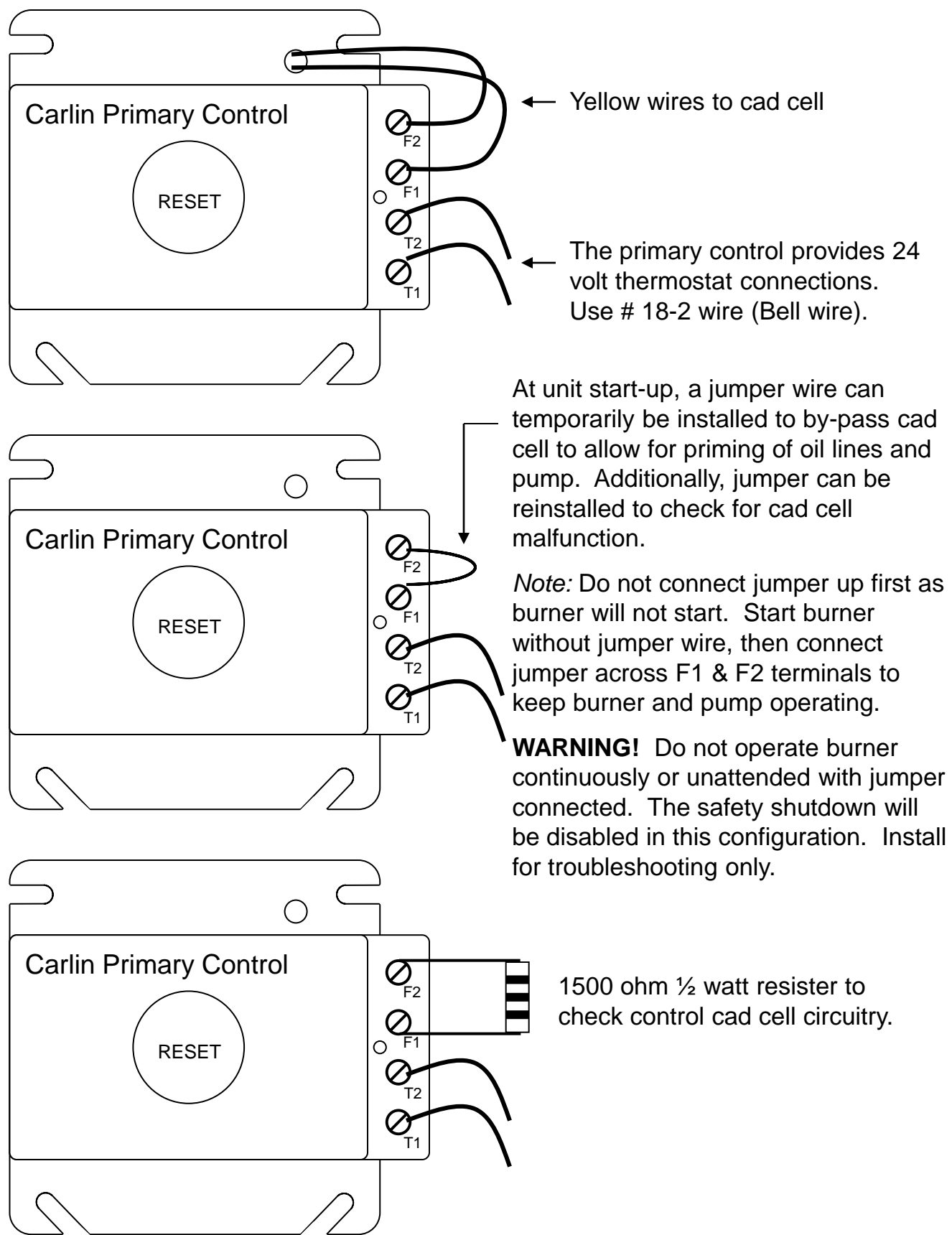
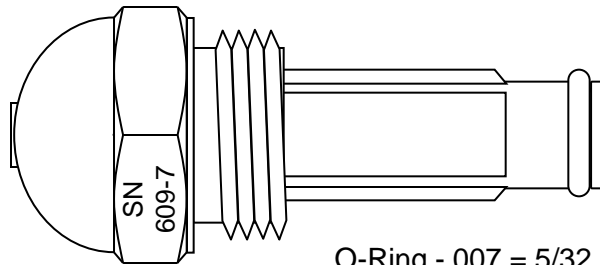
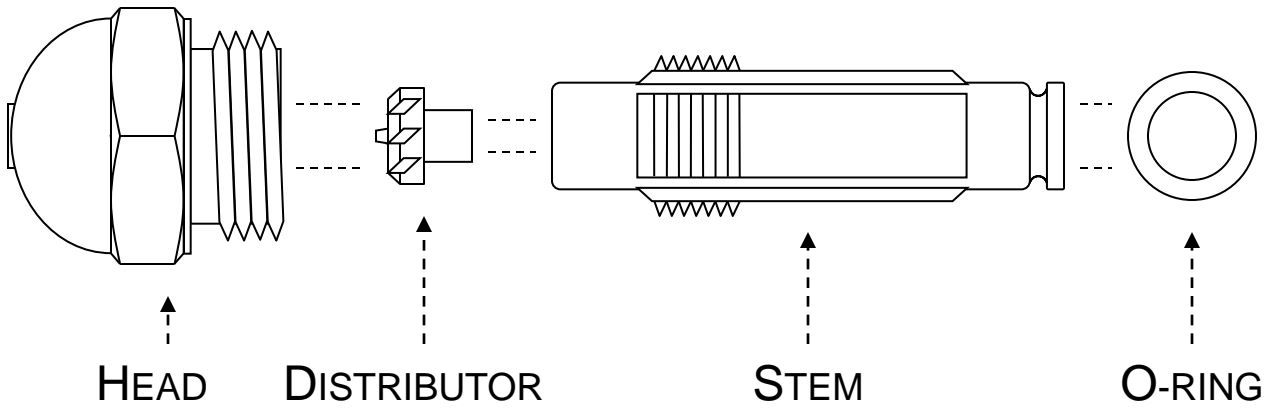

Figure 11

HEATWAVE NOZZLE – TYPICAL (HAGO)



O-Ring - 007 = 5/32 I.D. x 9/32 O.D. x 1/16

HEATWAVE NOZZLE – TYPICAL (DELAVAN)

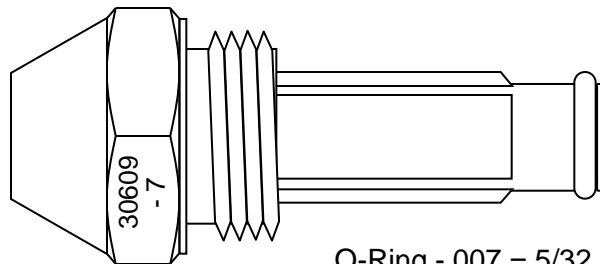
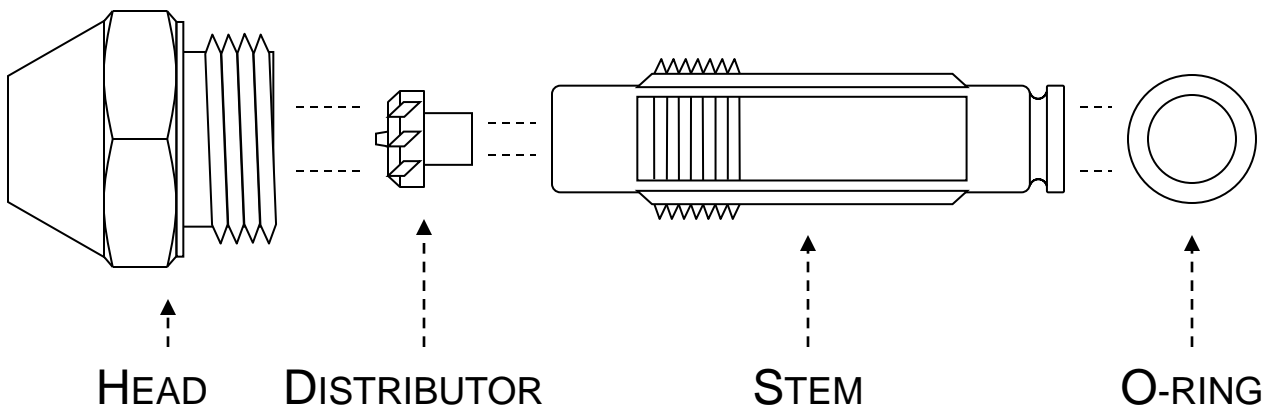

O-Ring - 007 = 5/32 I.D. x 9/32 O.D. x 1/16

Normal application: HW150 = 609-5, HW250 = 609-7, HW350 = 609-9

Figure 12

Adjustment of the Electrodes

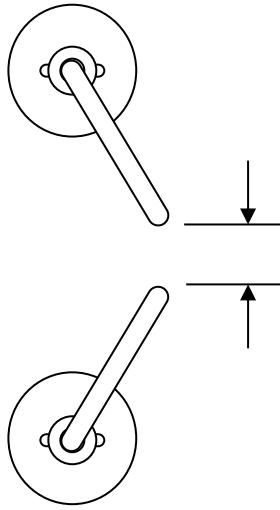

Do not exceed $5/32$ ".

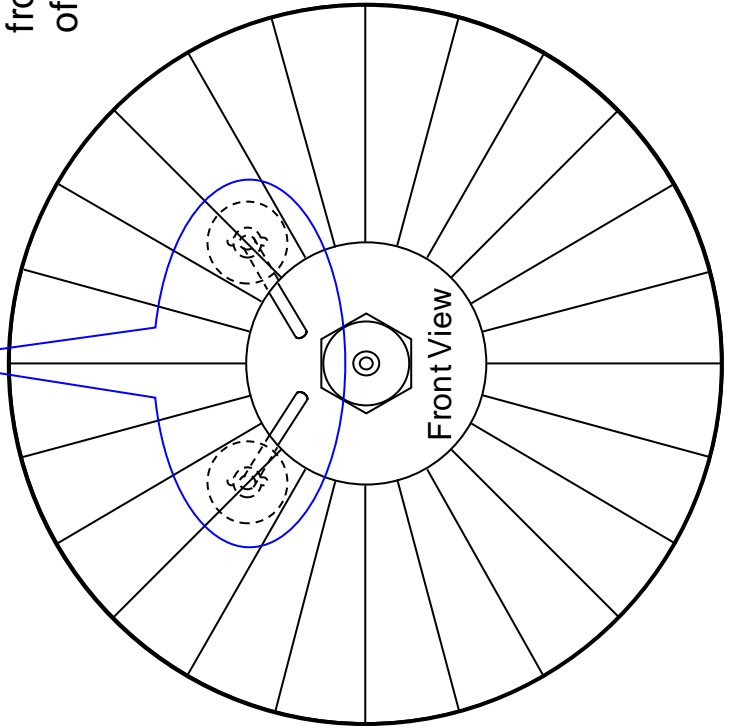

Retention Head

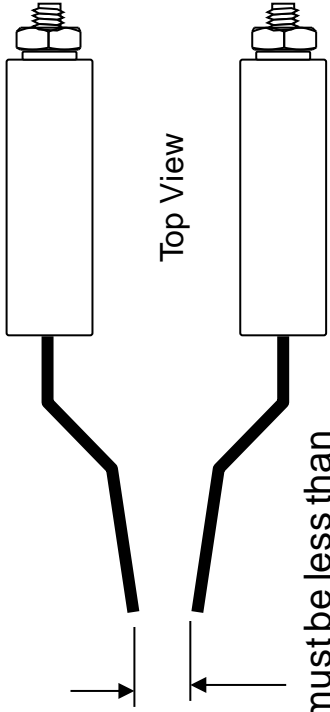

This gap must be less than electrode to ground. Do not exceed $5/32$ ".

Install electrodes so that there is an equal amount of ceramic in front of electrode and to the rear of the electrode holder.

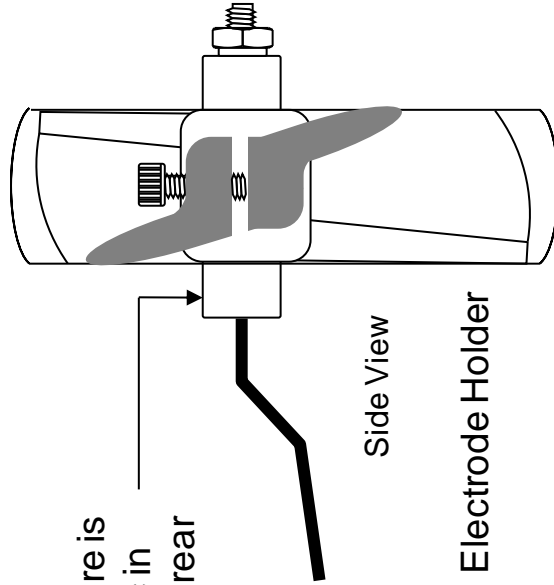

Tip Tapers down parallel to nozzle

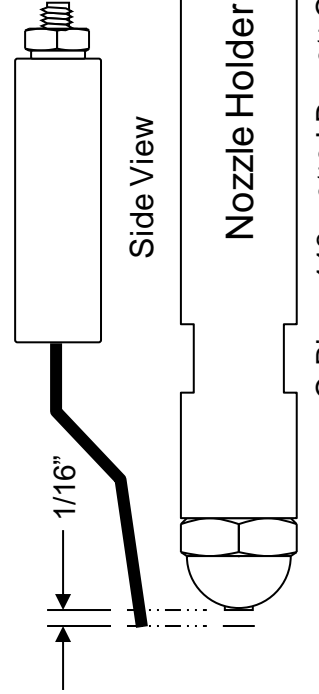

Side View

Nozzle Holder

O-Ring - 113 = $9/16$ I.D. x $3/4$ O.D. x $3/32$

Figure 13

AIR REGULATOR

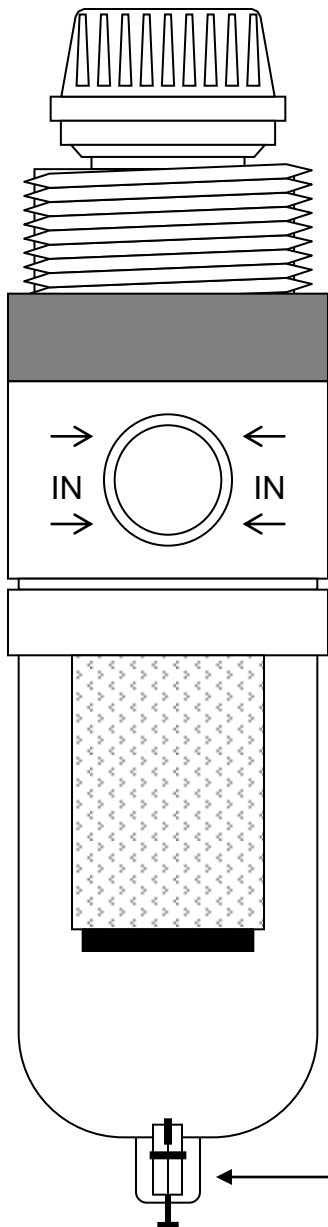

Pressure Adjustment Knob

Cap

Flat Washer

Main Spring

Diaphragm & Stem

Stem Guide

O-ring

Seat & Seat Spring

Regulator Body

Air Spinner

Filter Element

Filter Element
Retainer

Bowl O-ring

Filter Bowl

Water Drain

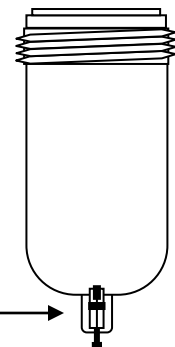
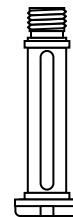
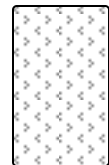
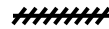
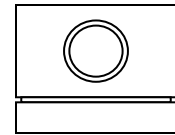
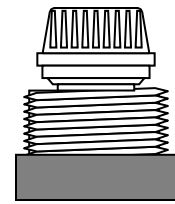

Figure 14

OIL REGULATOR

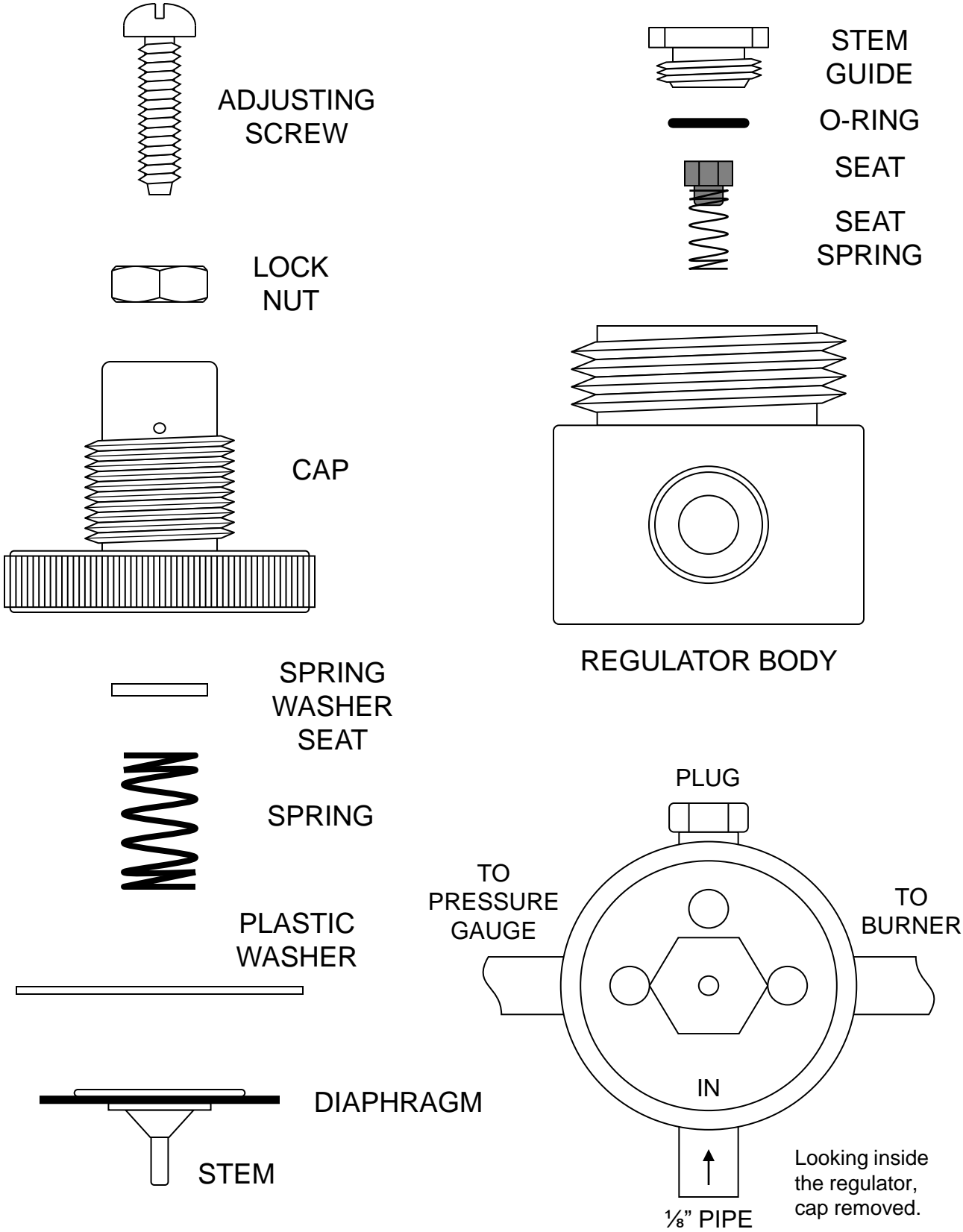
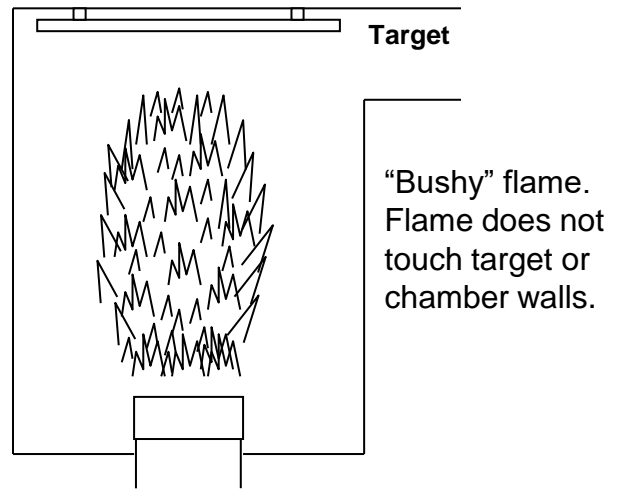

Figure 15

Flame Characteristics for adjusting oil pressure and troubleshooting

Warning: Over-firing the Heatwave will void the warranty and create a fire hazard.



Correct maximum flame

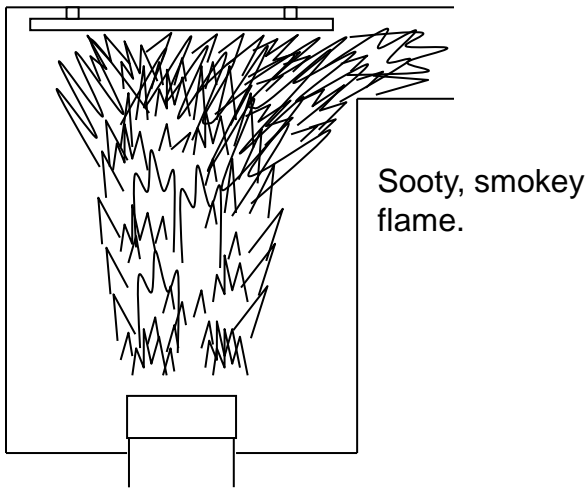

Excessive oil pressure.
Insufficient combustion air.

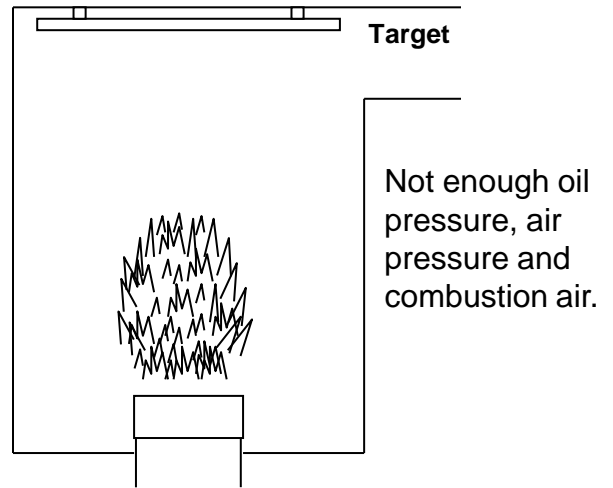

Under fired

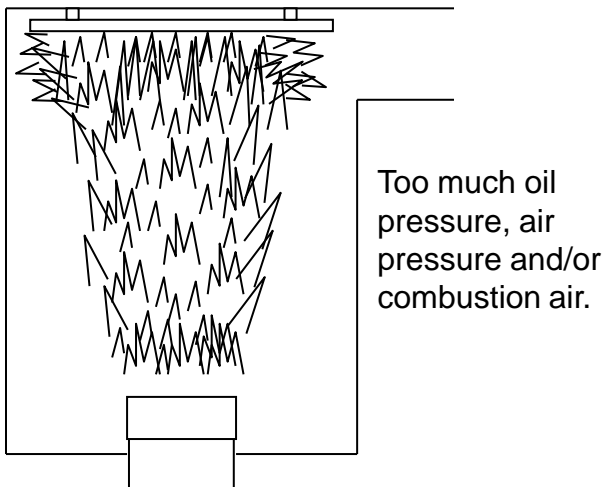

Over fired.
Target area red hot.

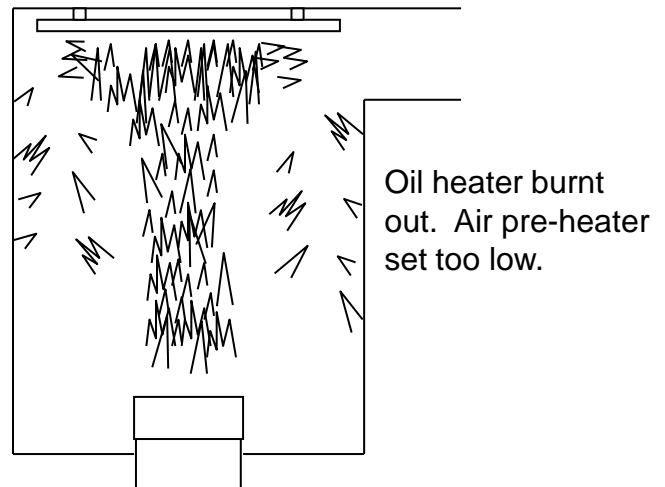

Oil too cold

Figure 16

EXPLODED VIEW OF AIR / OIL SOLENOID

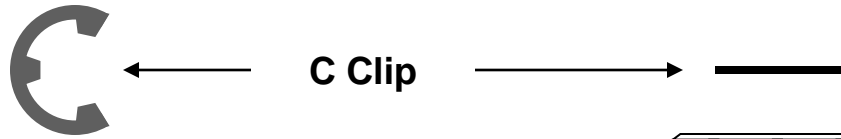

C Clip

Note:

When disassembling the valve body, be aware of the o-ring at the bottom of the seat body. Black o-rings are easily hidden in the pooled black waste oil.

Coil

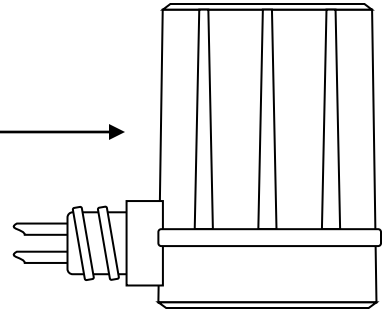

Spacer

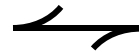

Piston Housing (stem)



Piston Spring

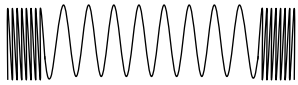

Piston (Nucleus)

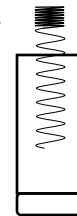

O-ring



013 = 7/16 I.D. x 9/16 O.D. x 1/16

Seat Body

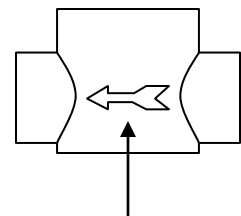

Direction of Flow Arrow

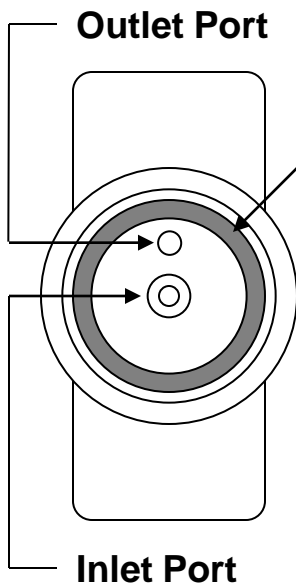
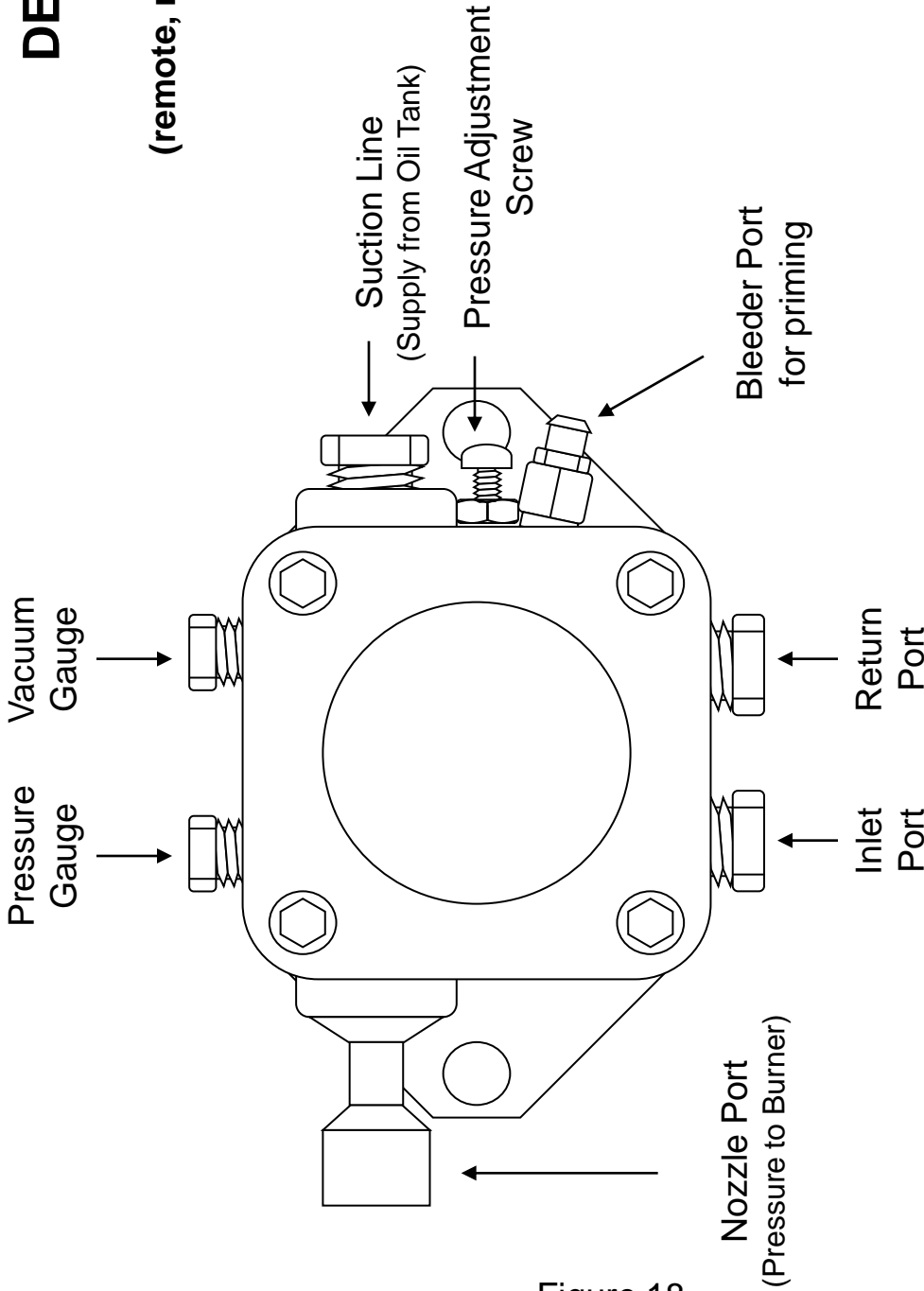

Figure 17

DELTA PUMP CV2RR

(remote, non burner mounted)



Delta pump shown with
screws, cover and screen
removed for cleaning.

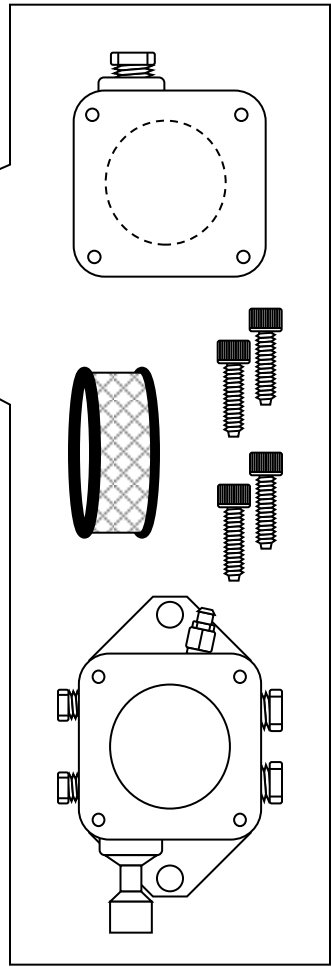

Note:
Pump will not prime if mounted upside down

Figure 18

SUNTEC "J" PUMP

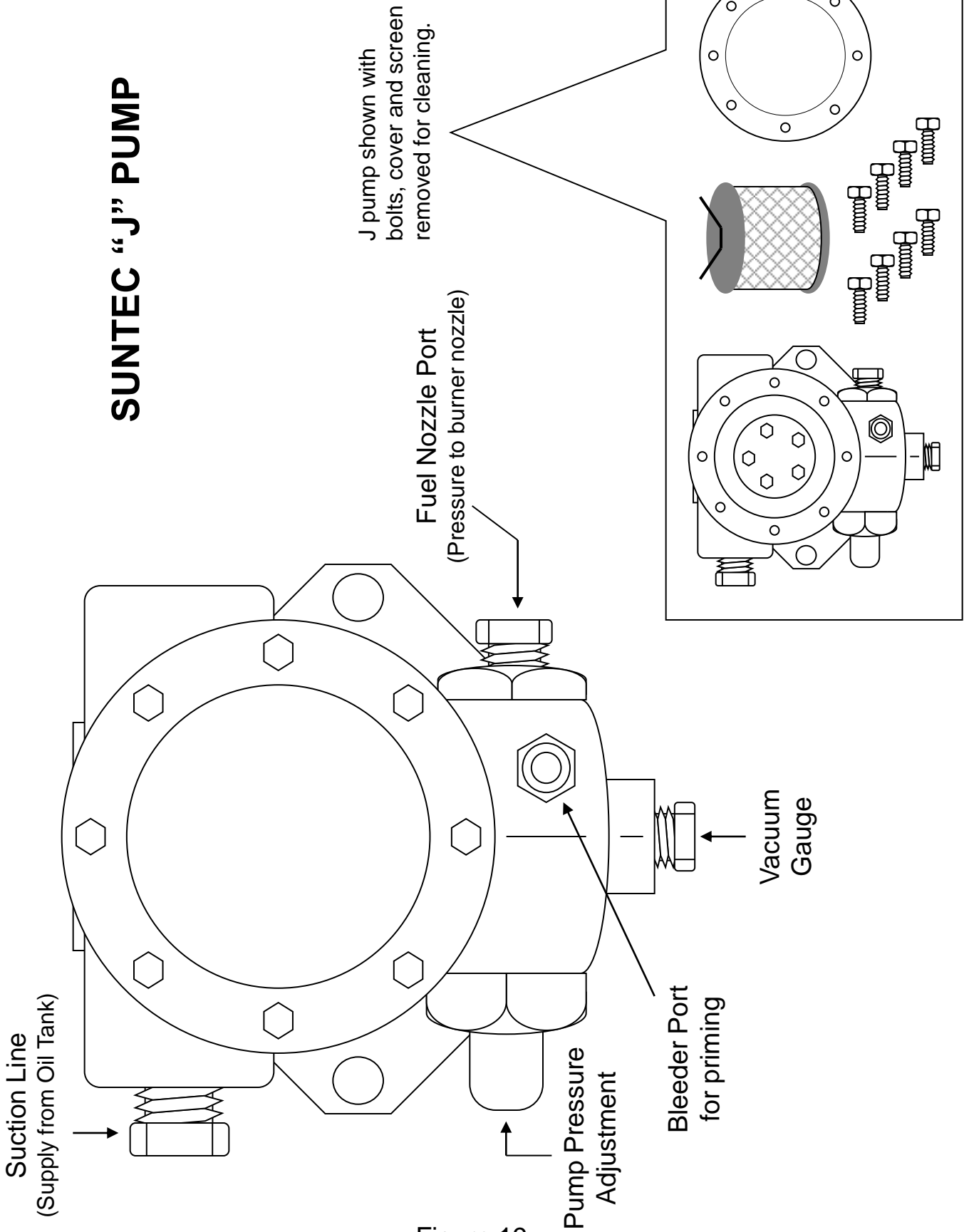

Figure 19

SUNTEC PUMP A2RA-7740

(remote, non burner mounted)

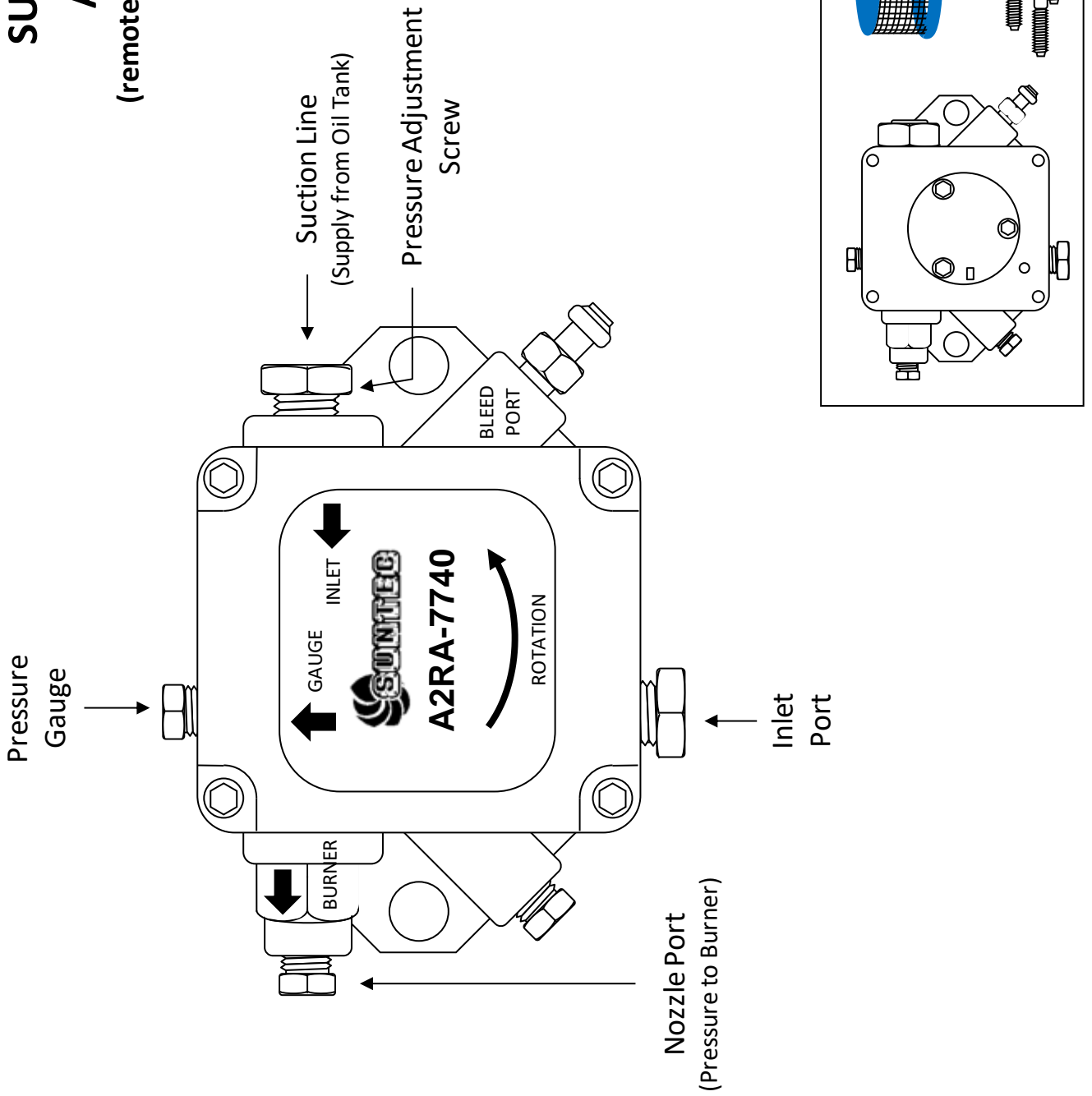
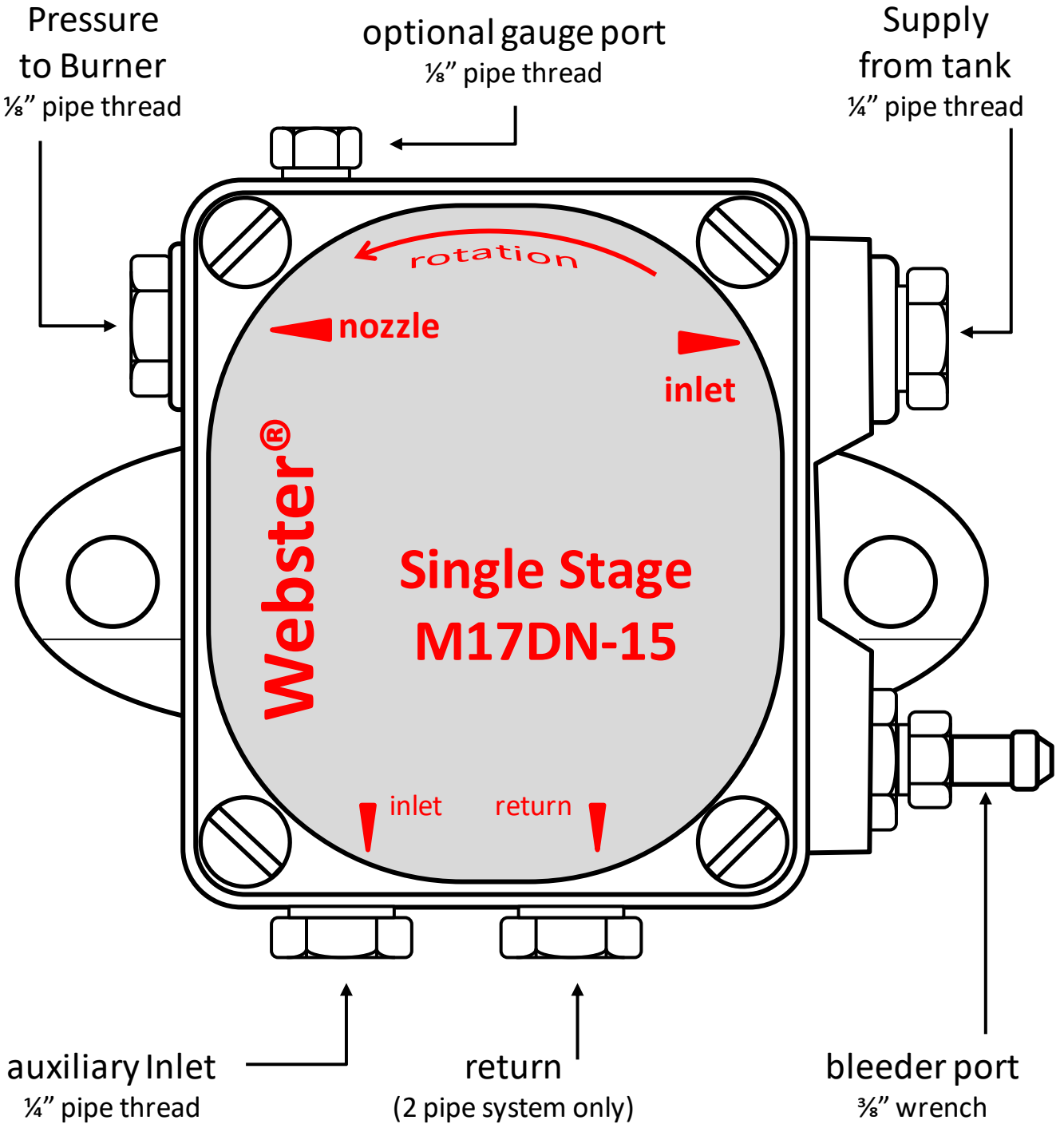

Figure 20

WEBSTER M17DN-15



Attention – Webster pumps are maintenance free and do not have an internal filter. DO NOT disassemble!

Figure 21

WEBSTER

1RR14004EK13

(REPLACES SUNTECJ-SERIES)

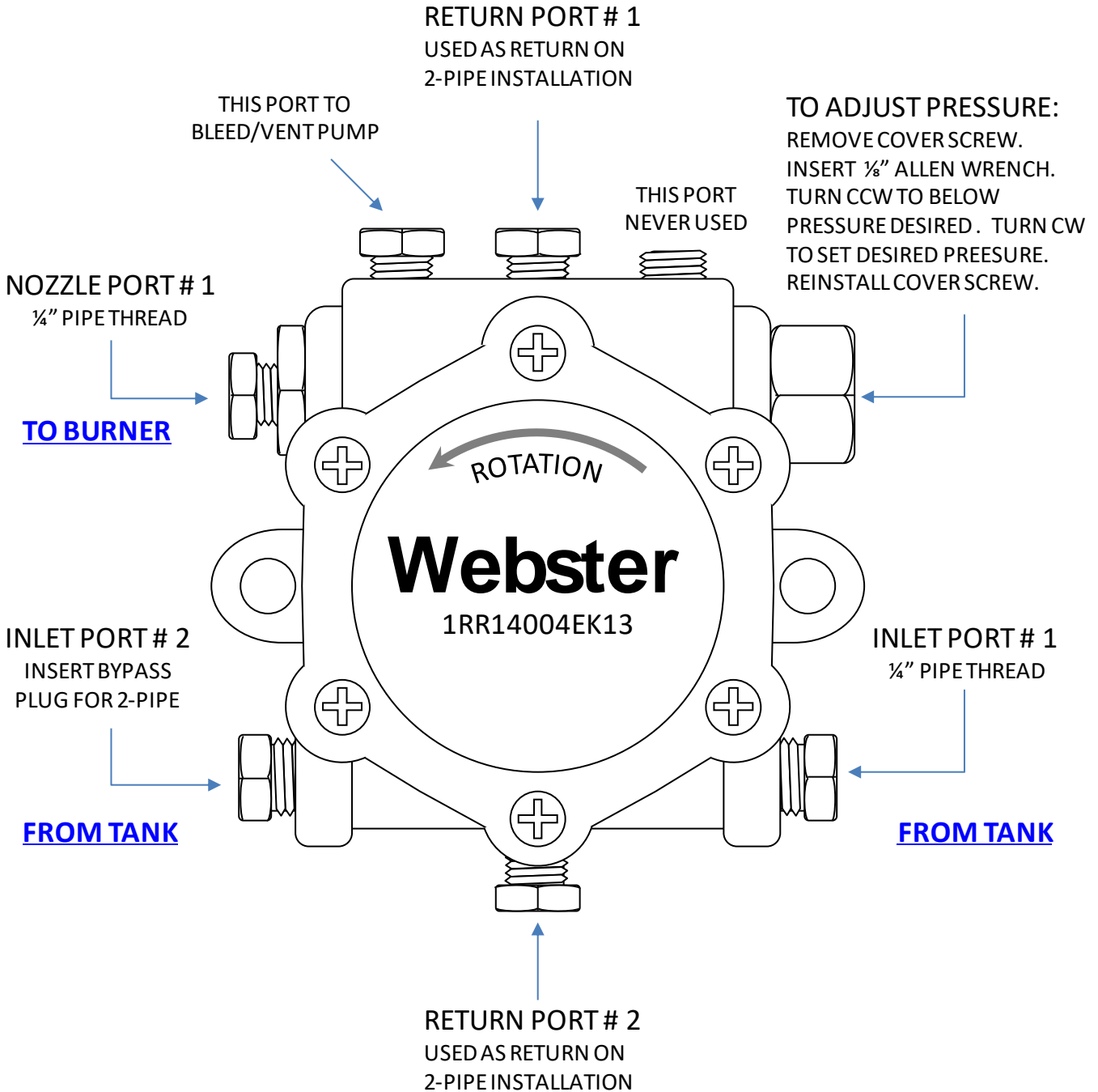
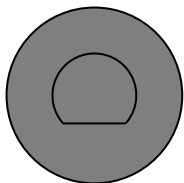
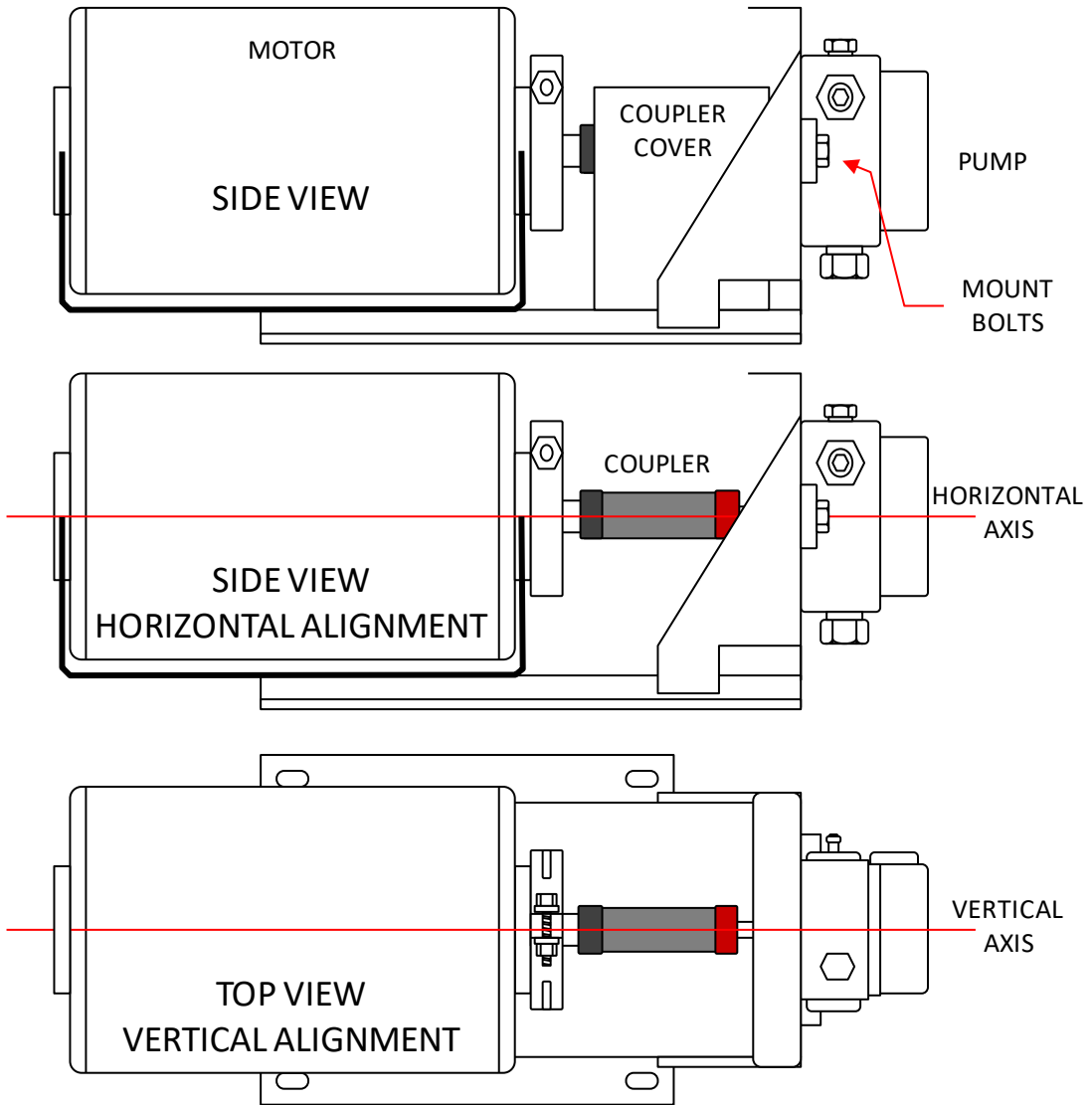
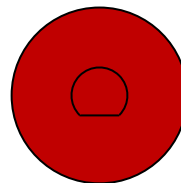

Figure 22

Pump to Motor Alignment



MOTOR SHAFT
END 1/2" Ø



PUMP SHAFT
END 5/16" Ø

LOOK FOR WEAR IN THESE AREAS

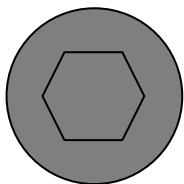

COUPLER SHAFT
MATERIAL

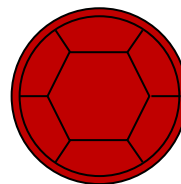

INSIDE PUMP
SHAFT END

Note: "J" pump, pump shaft end is 7/16" blue

Figure 23

LENZ FILTER SYSTEM

3/8" 16 UNC Mount Holes

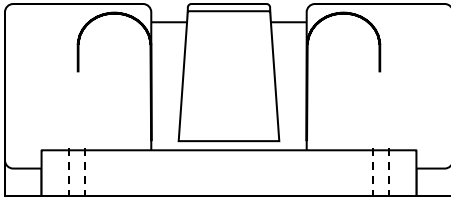

Filter Head

3/4" NPT



Bowl O-ring

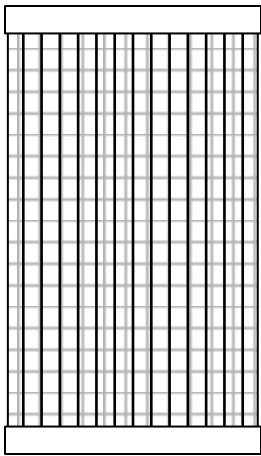

100 Mesh
SS Filter

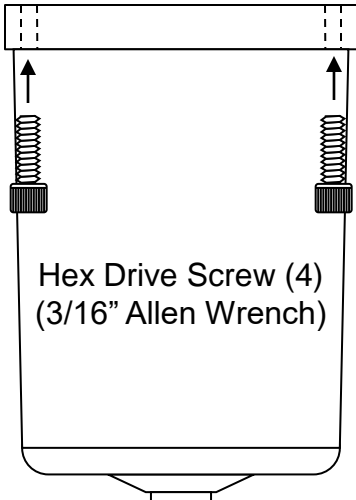

Hex Drive Screw (4)
(3/16" Allen Wrench)

Filter Bowl



Drain Plug O-ring



Drain Plug

Internal Wrenching Plug
(1/4" Allen Wrench)

To Clean:

Remove 4 hex head screws and lower filter bowl. Filter element can be removed by pulling downward with a slight twisting motion. Clean element and bowl with solvent.

Be careful not loose, cut or twist bowl o-ring upon reinstallation.

Fill bowl approximately 2/3 full with clean oil prior to installing to aid in pump priming.

Install bowl (with o-ring in place) and tighten screws evenly to reduce the possibility of suction leaks.

ATTENTION!

DO NOT USE FILTER ASSEMBLIES WITH RELIEF OR BYPASS

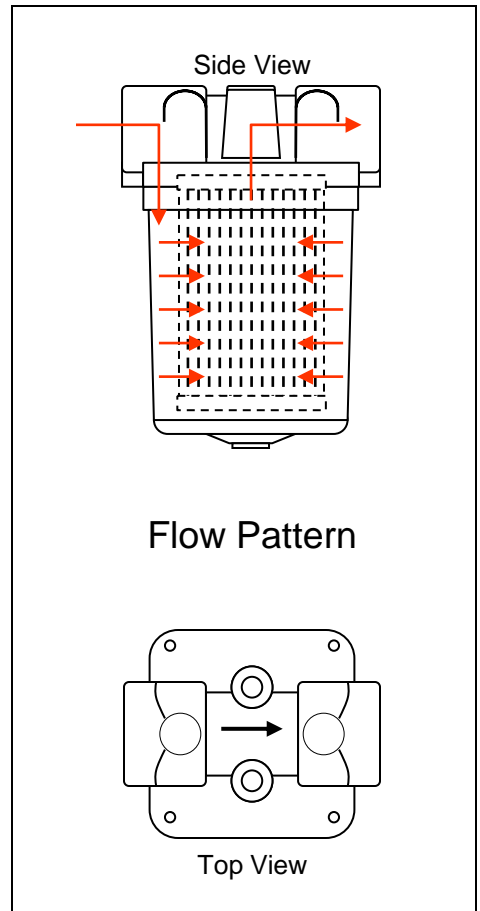
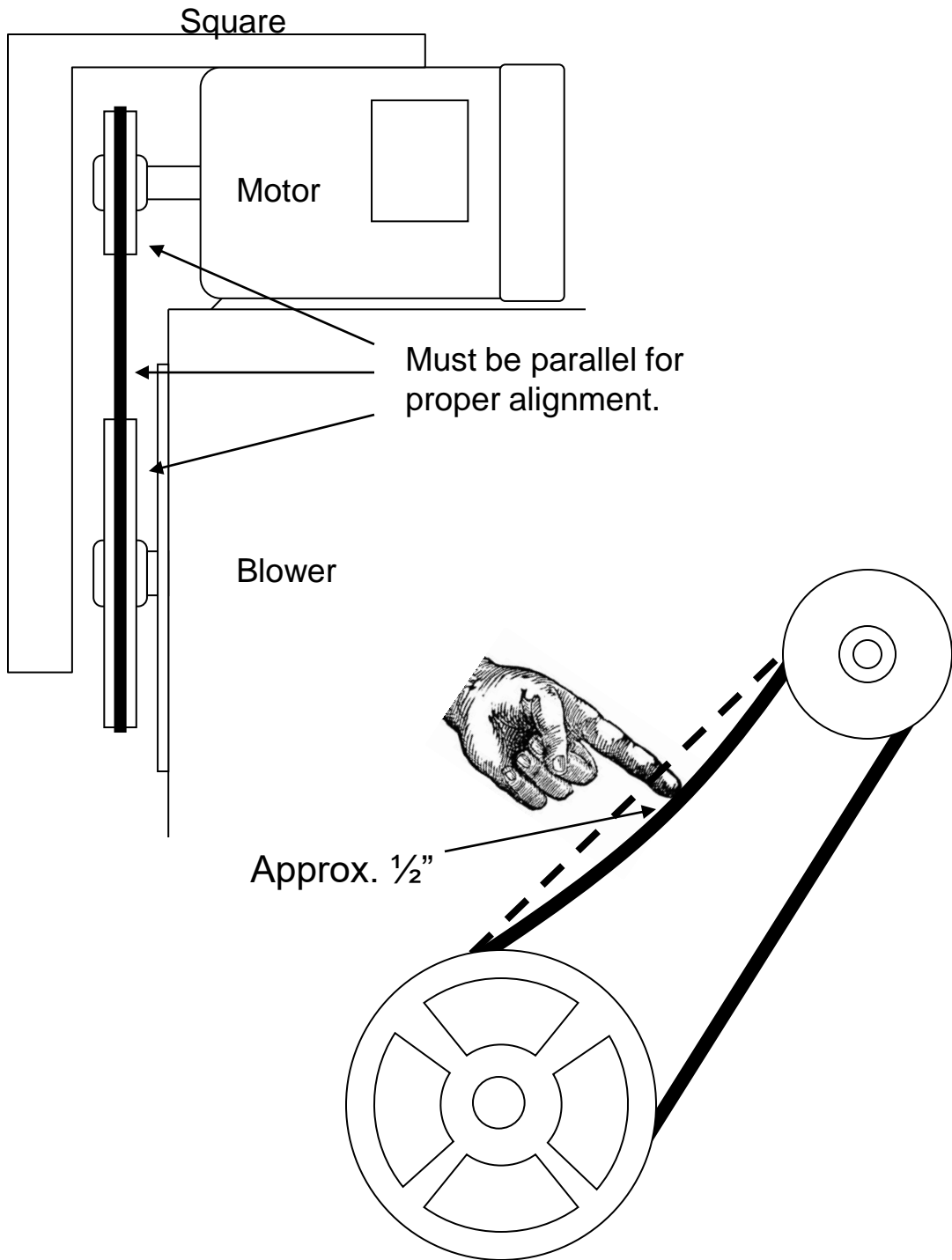

Figure 24



Blower Belt – Alignment and Tension

SQUARE D BREAKER BOX – HEATWAVE (120V)

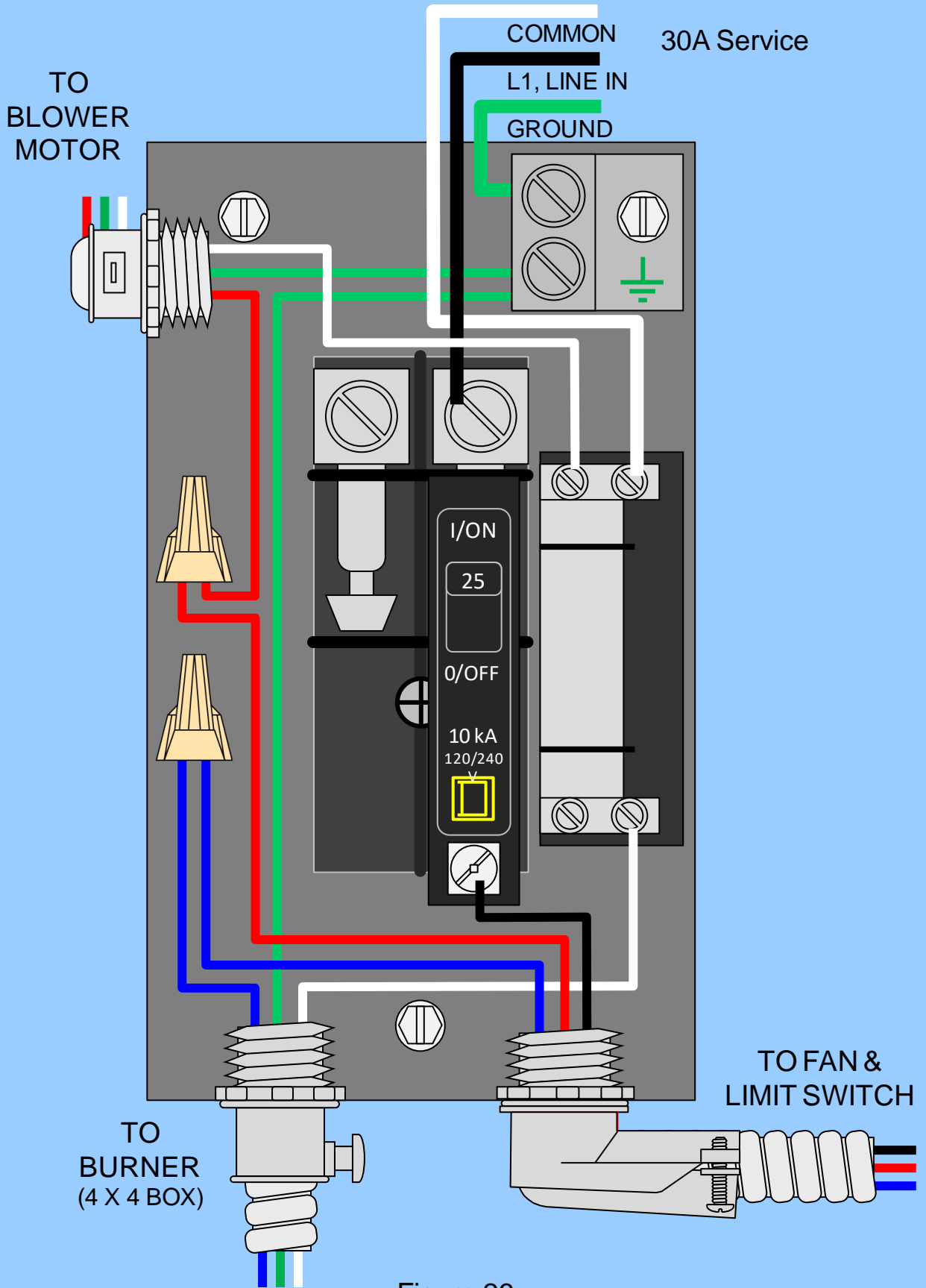

Figure 26

WIRING SCHEMATIC – TYPICAL HEATWAVE

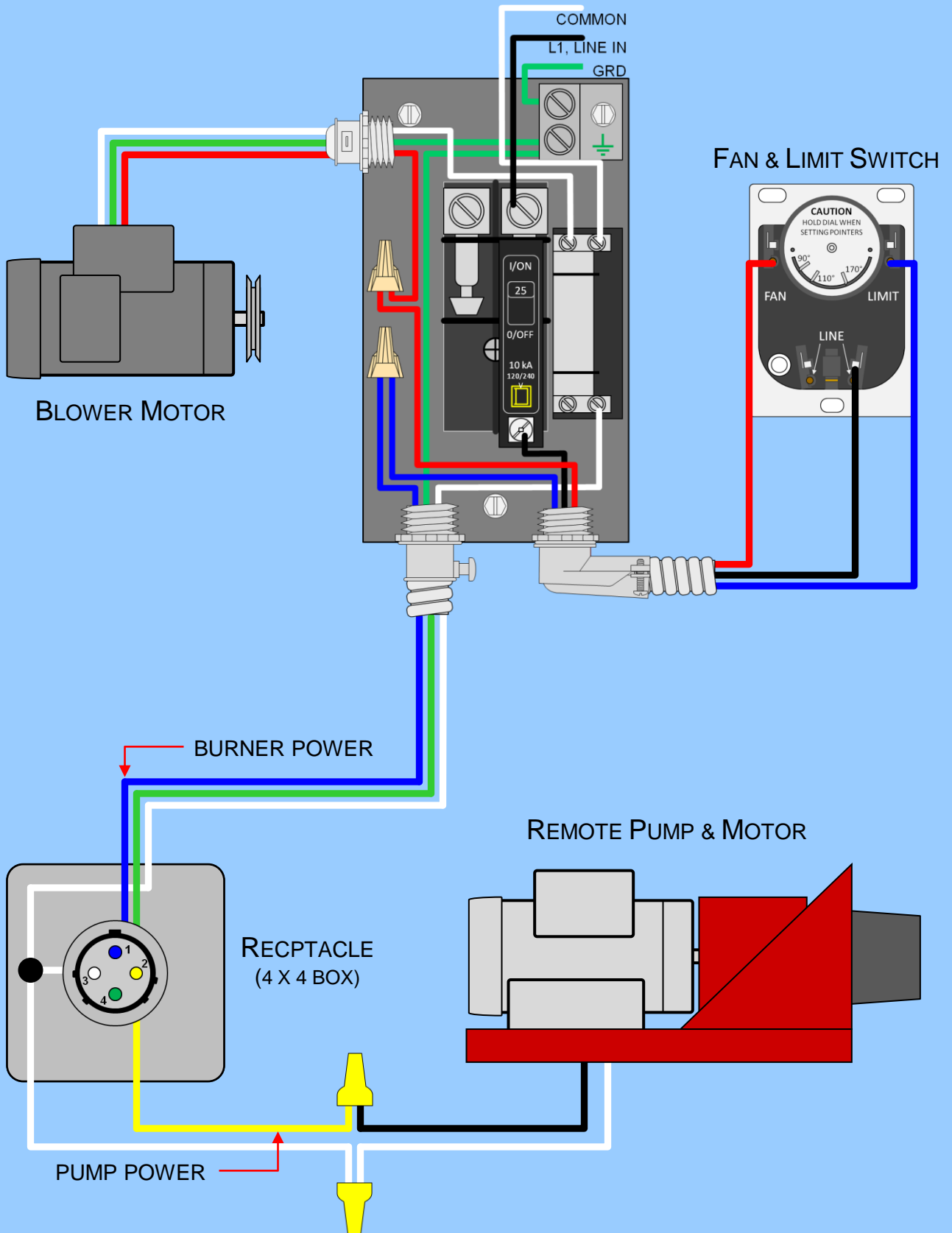

Figure 27

BURNER WIRING DIAGRAM

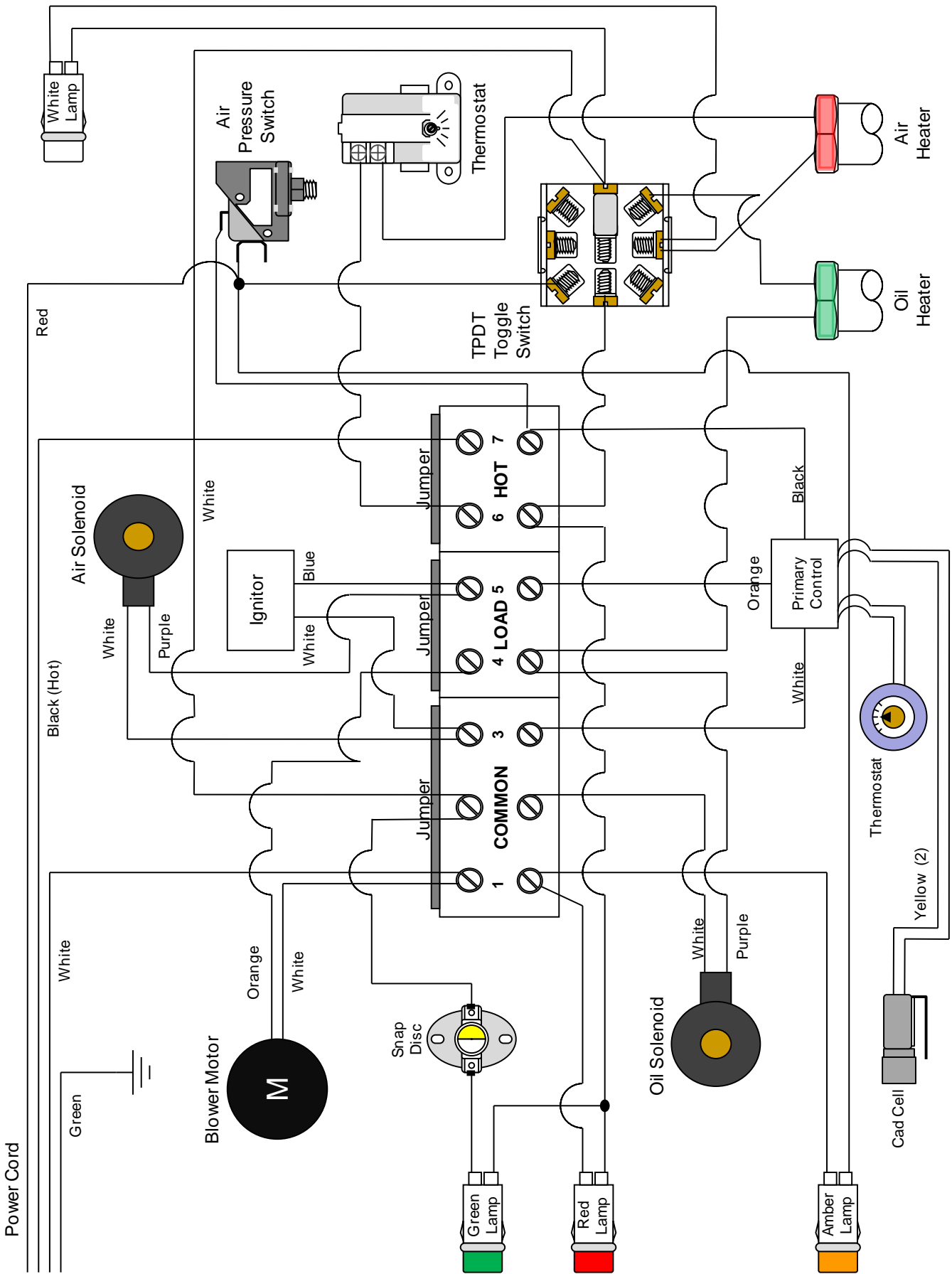
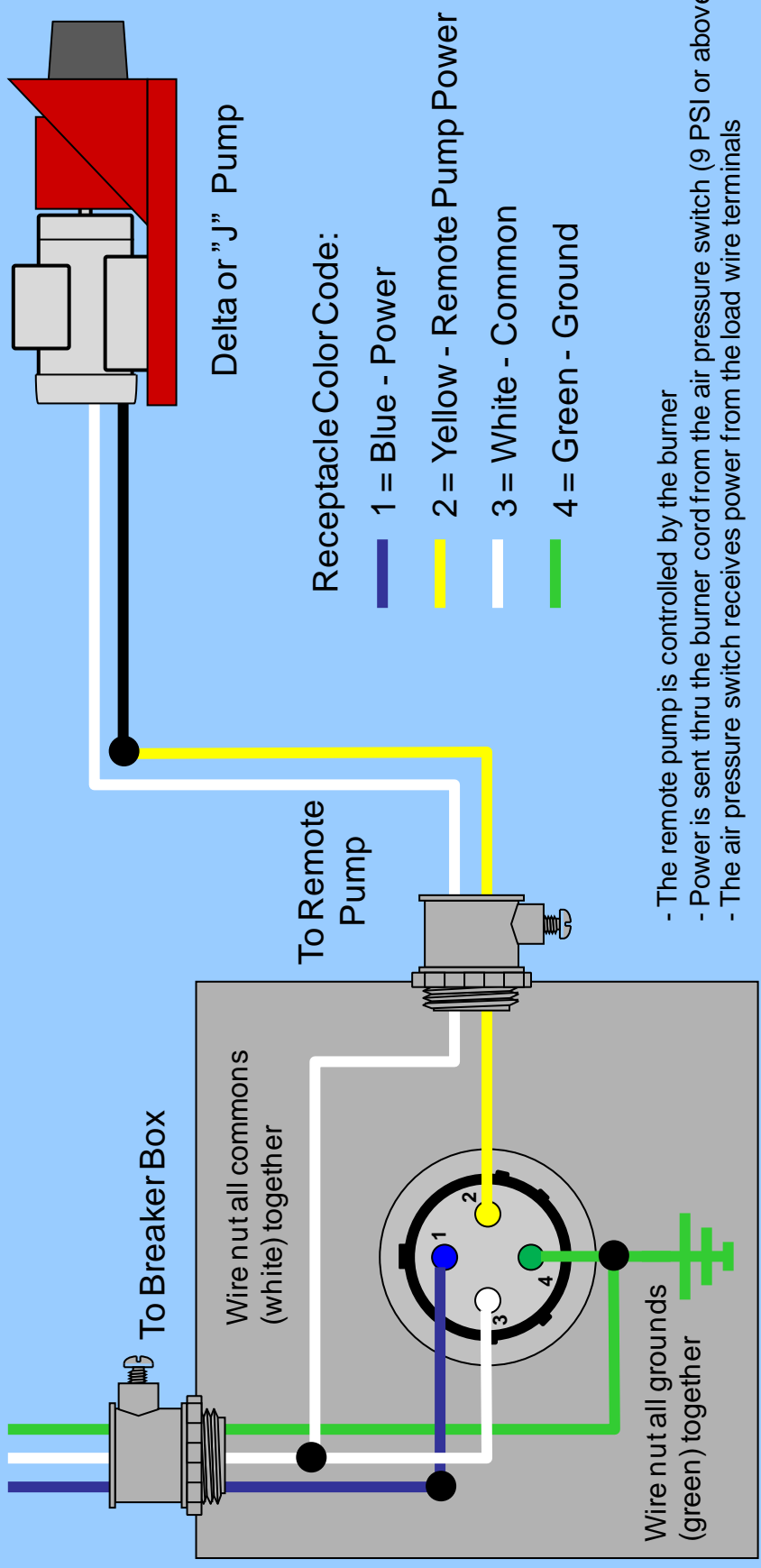

Figure 28

4 X 4 Junction Box



Delta or "J" Pump

Receptacle Color Code:

- 1 = Blue - Power
- 2 = Yellow - Remote Pump Power
- 3 = White - Common
- 4 = Green - Ground

- The remote pump is controlled by the burner
- Power is sent thru the burner cord from the air pressure switch (9 PSI or above)
- The air pressure switch receives power from the load wire terminals

Cord Color Code:

- 1 = Black - Power
- 2 = Red - Remote Pump Power
- 3 = White - Common
- 4 = Green - Ground

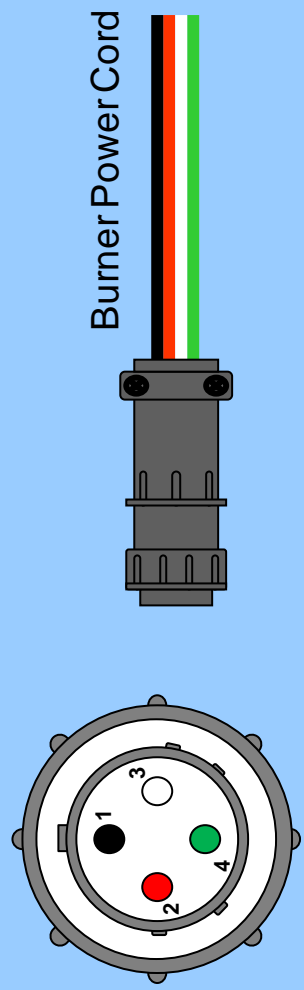
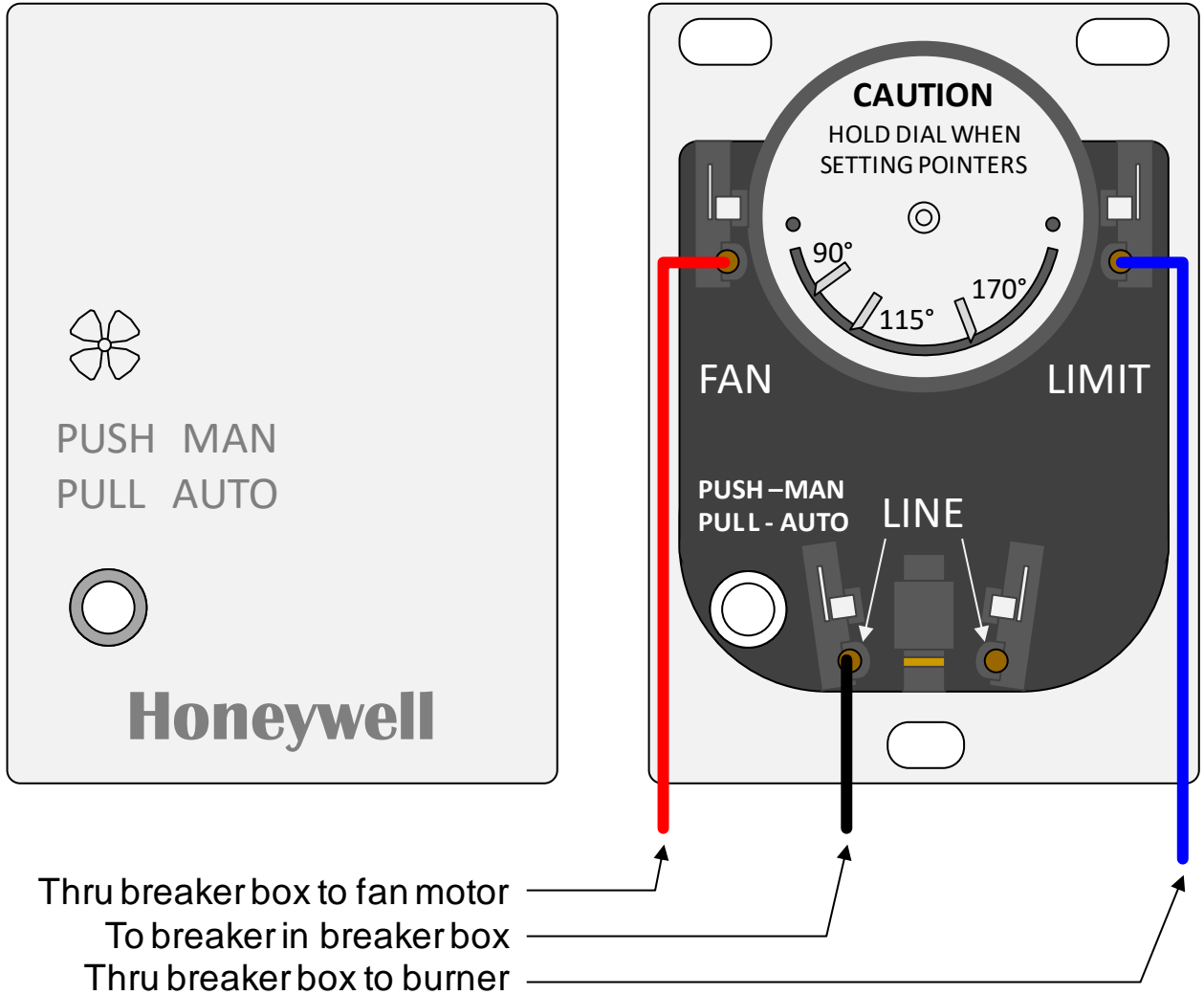

FIGURE 29

HONEYWELL FAN & LIMIT CONTROL L4064B2236

Fan Off: 90 Fan On: 115 High limit: 170



Caution: When adjusting set point levers, hold the scaleplate dial to keep it from turning and straining the sensing equipment

*Note: For constant fan operation, push button in to "MAN".
For fan to cycle automatically, set (pull) switch to "AUTO".*

Figure 30

WHITE-RODGERS FAN & LIMIT CONTROL 5D51-90

Fan Off: 90 Fan On: 115 High limit: 170

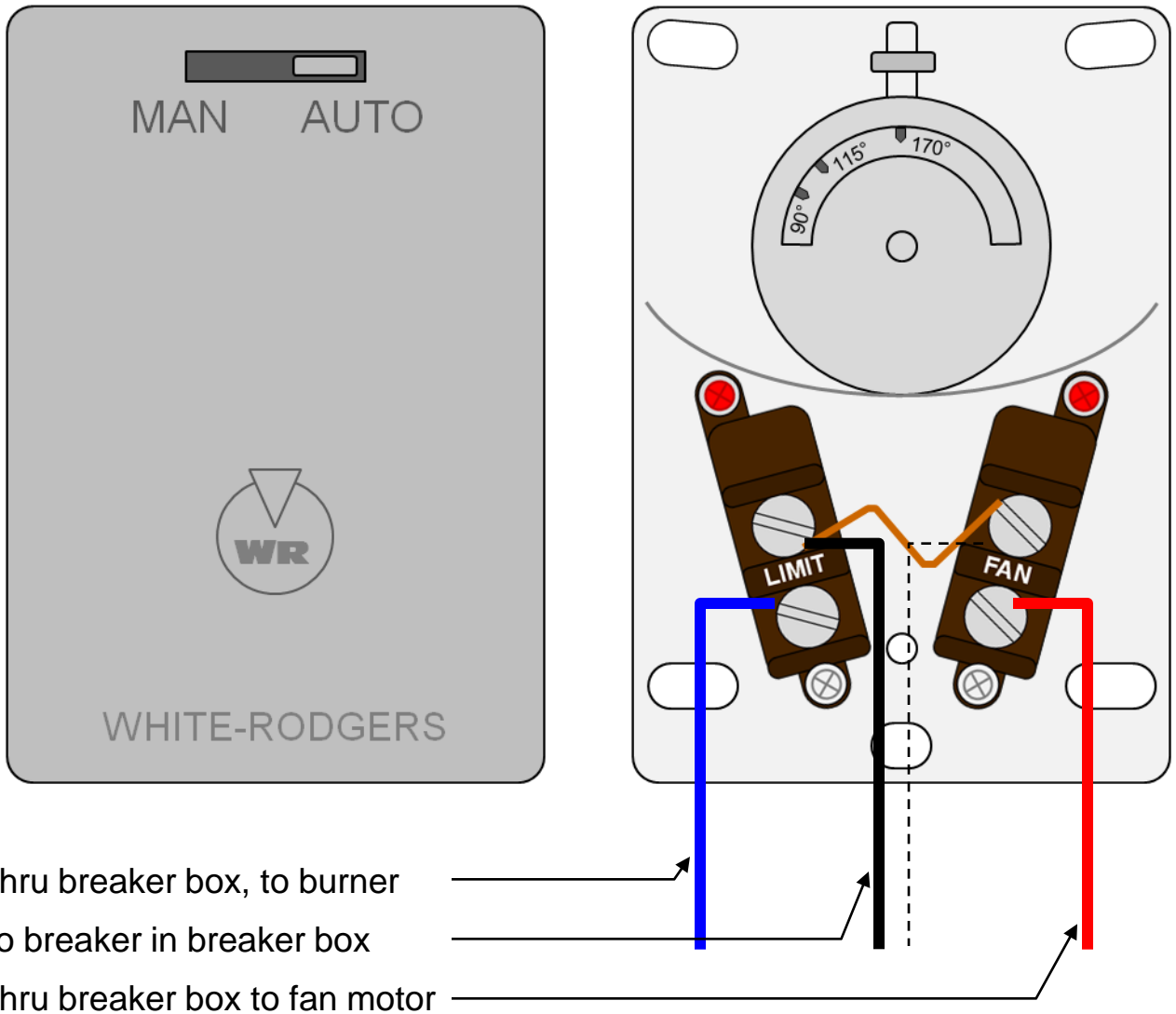

Caution: When adjusting set point levers, hold the scaleplate dial to keep it from turning and straining the sensing equipment

Note: For constant fan operation, slide manual fan switch to "MAN". For fan to cycle automatically, set switch to "AUTO".

Figure 31

KAGI TERMINAL BLOCK

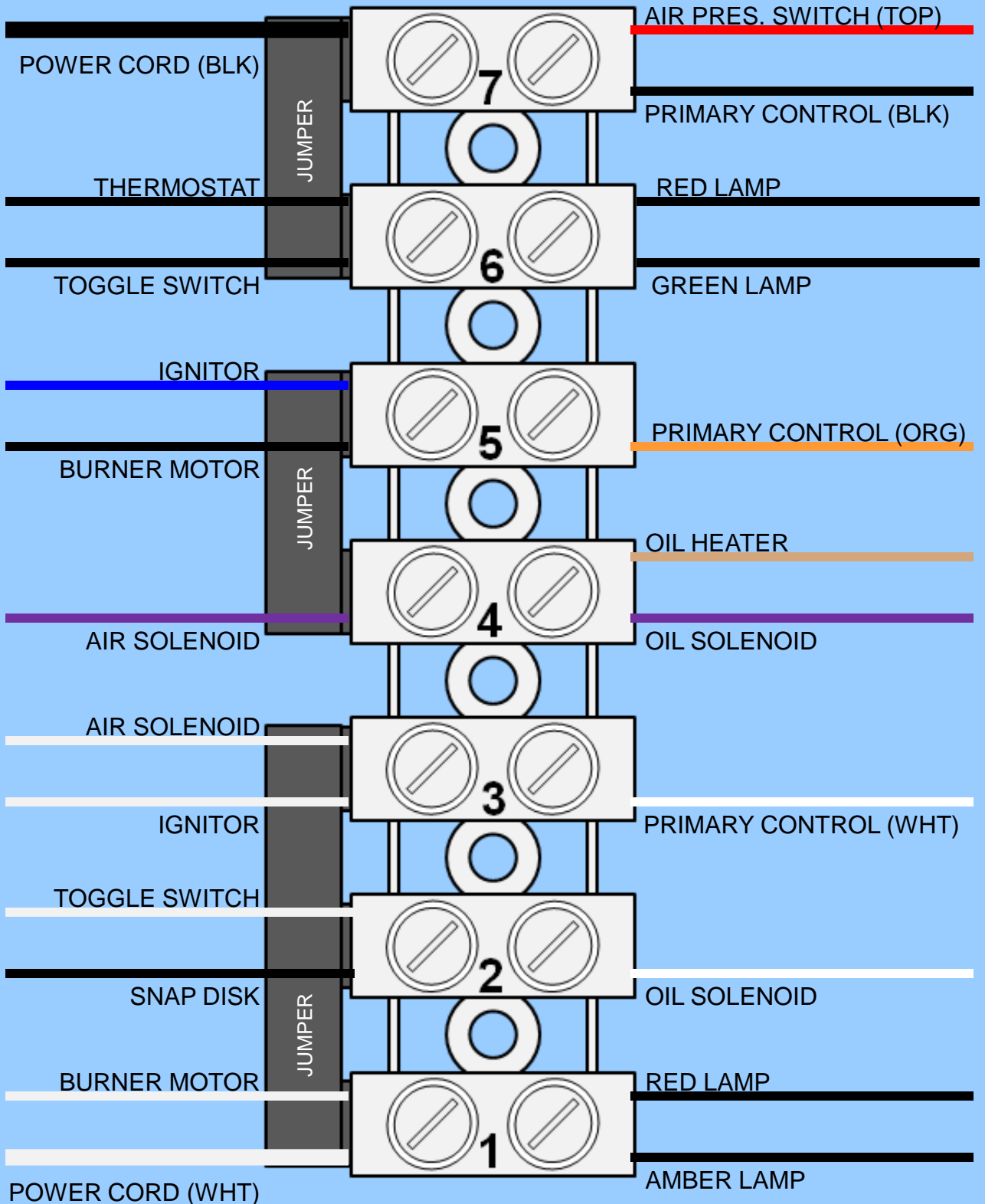

Note: Actual wire colors may differ

Figure 32

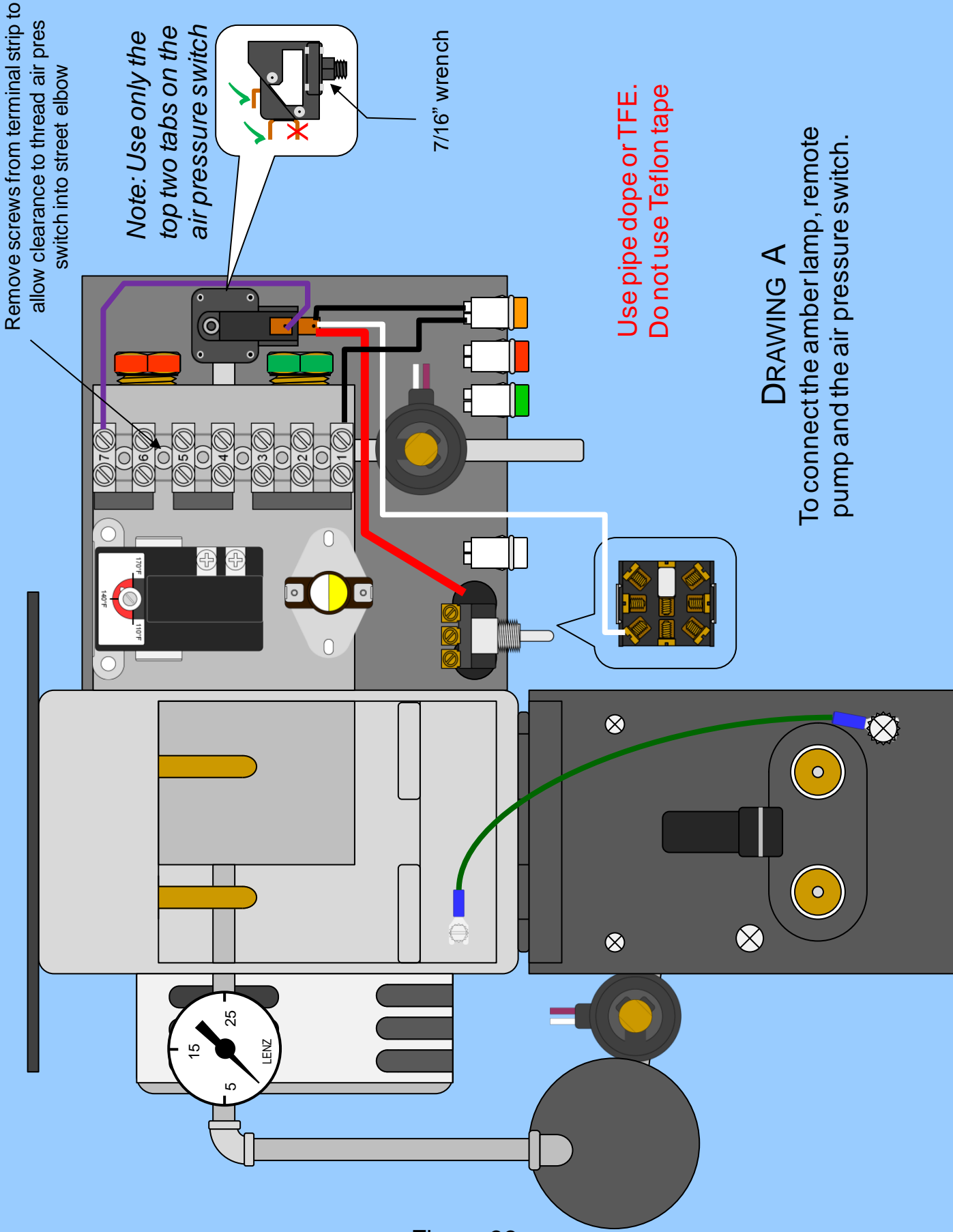
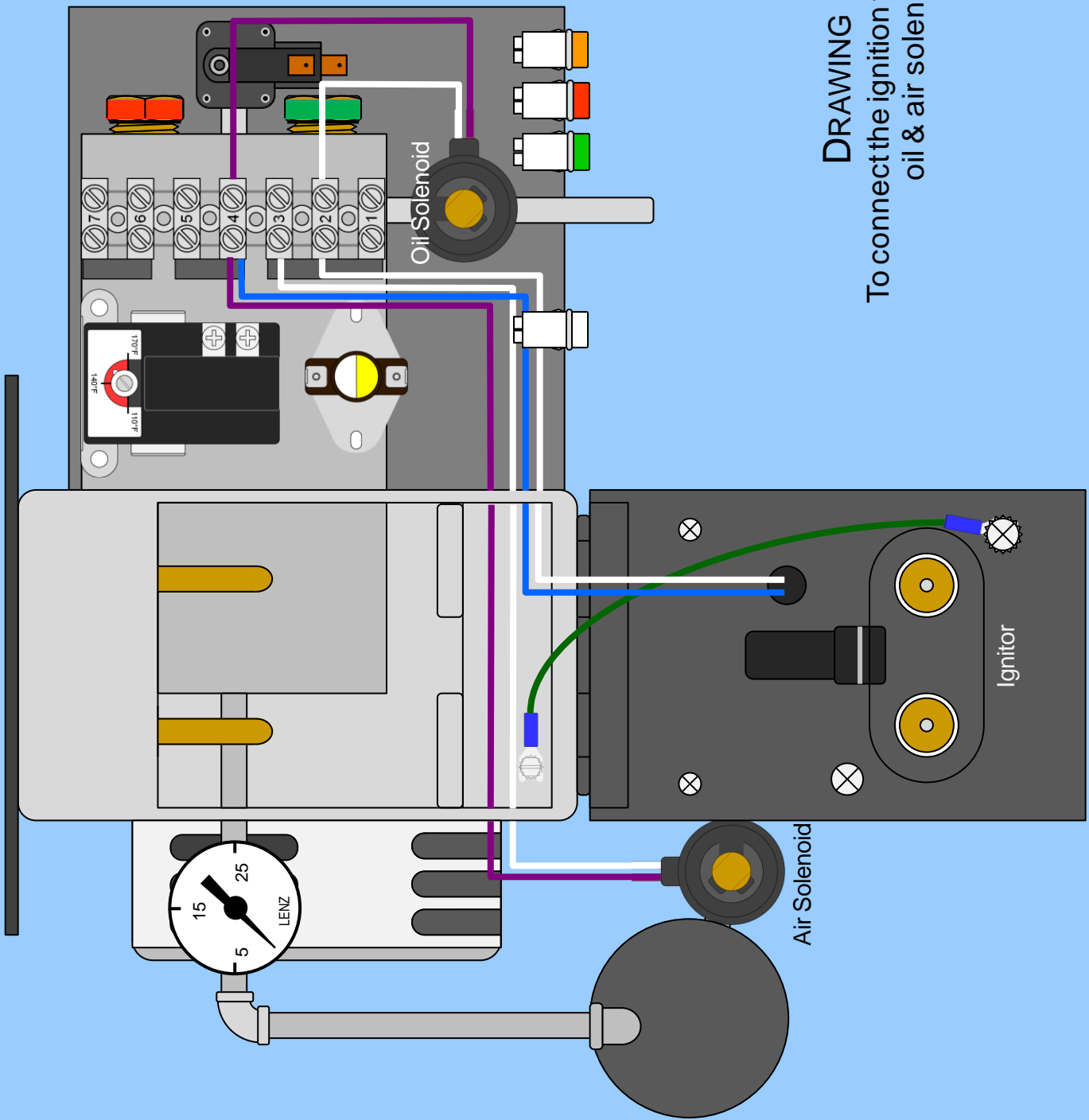
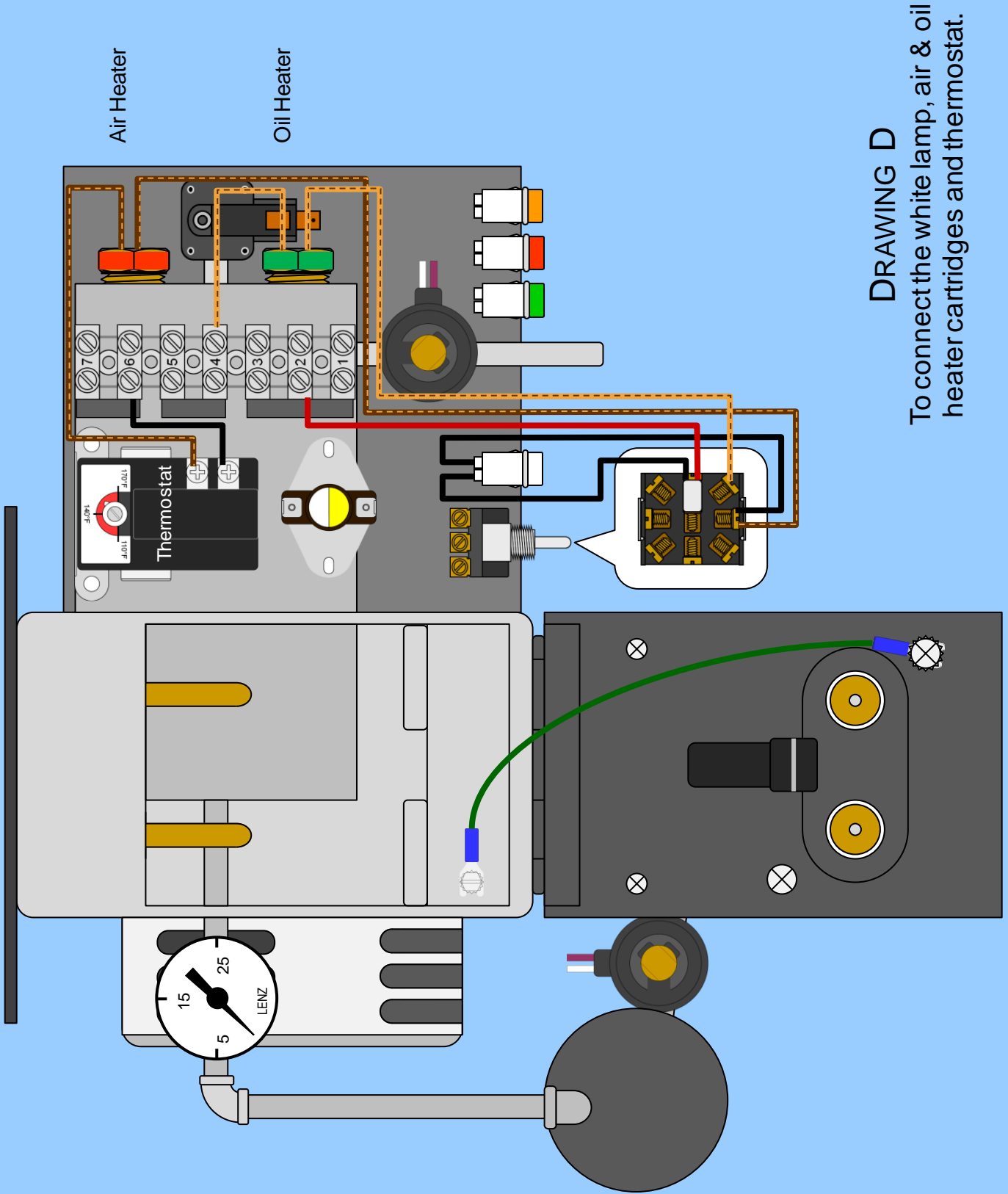

Figure 33



DRAWING B
 To connect the ignition transformer,
 oil & air solenoid

Figure 34



DRAWING D

To connect the white lamp, air & oil heater cartridges and thermostat.

Figure 36

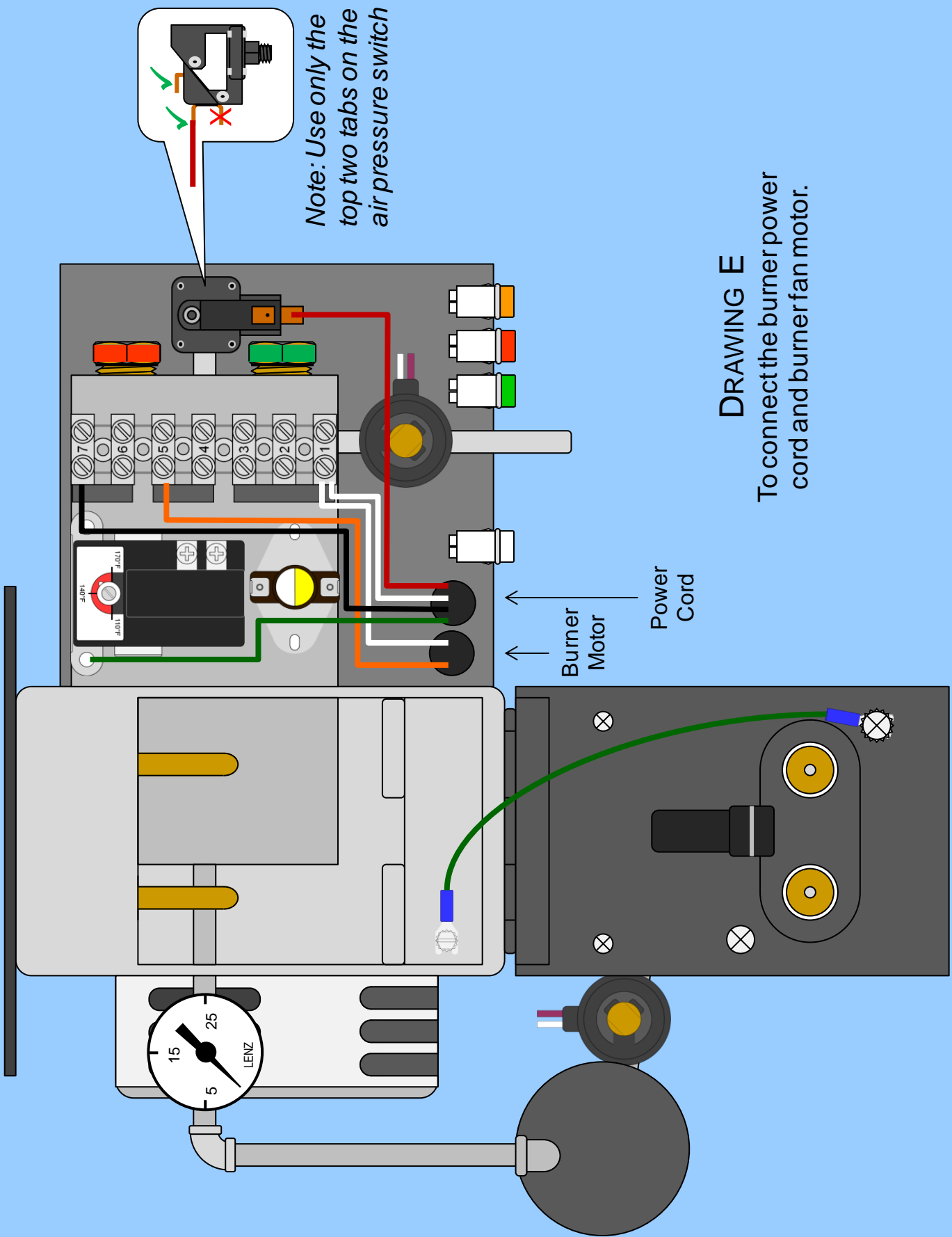
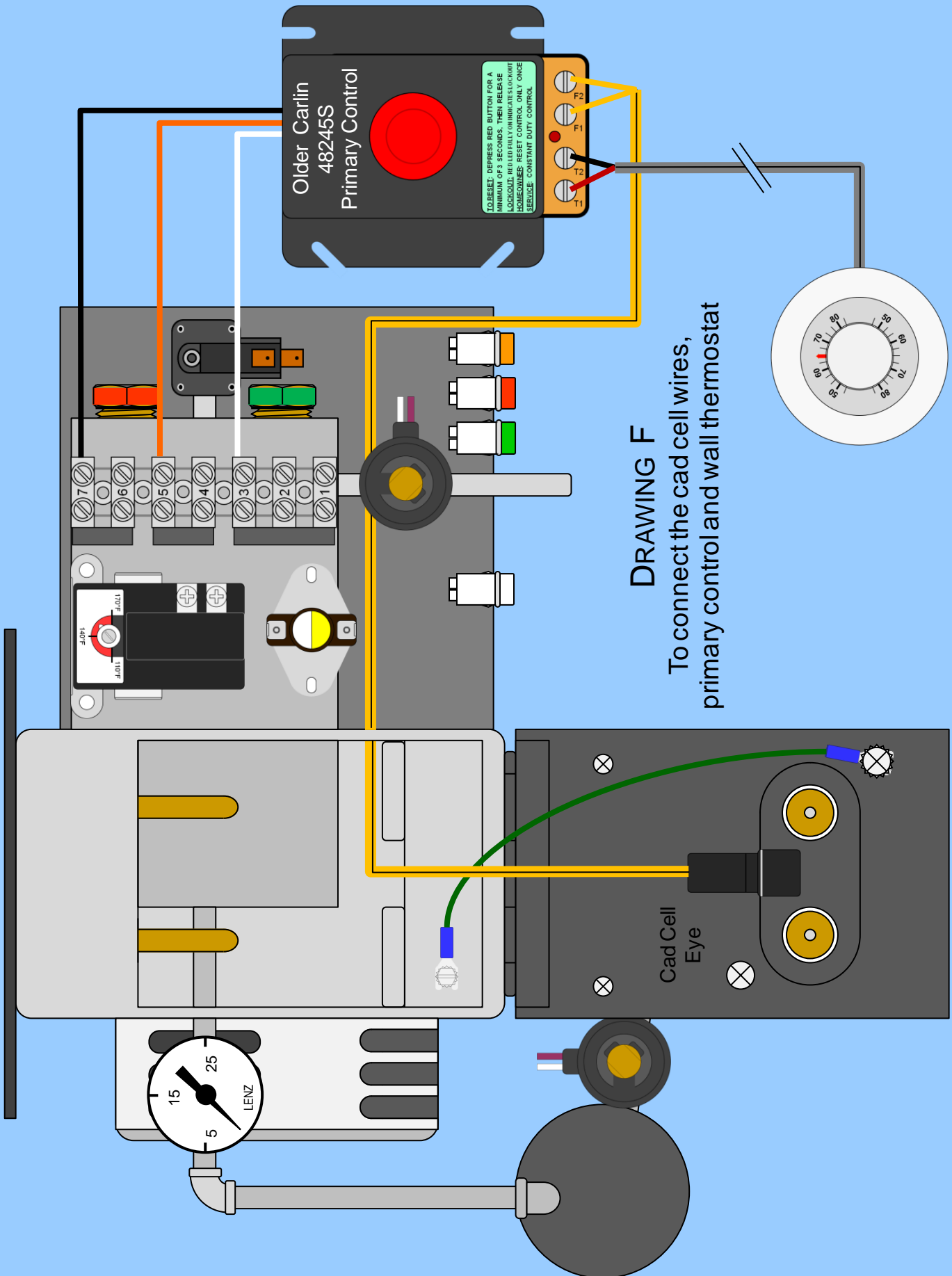
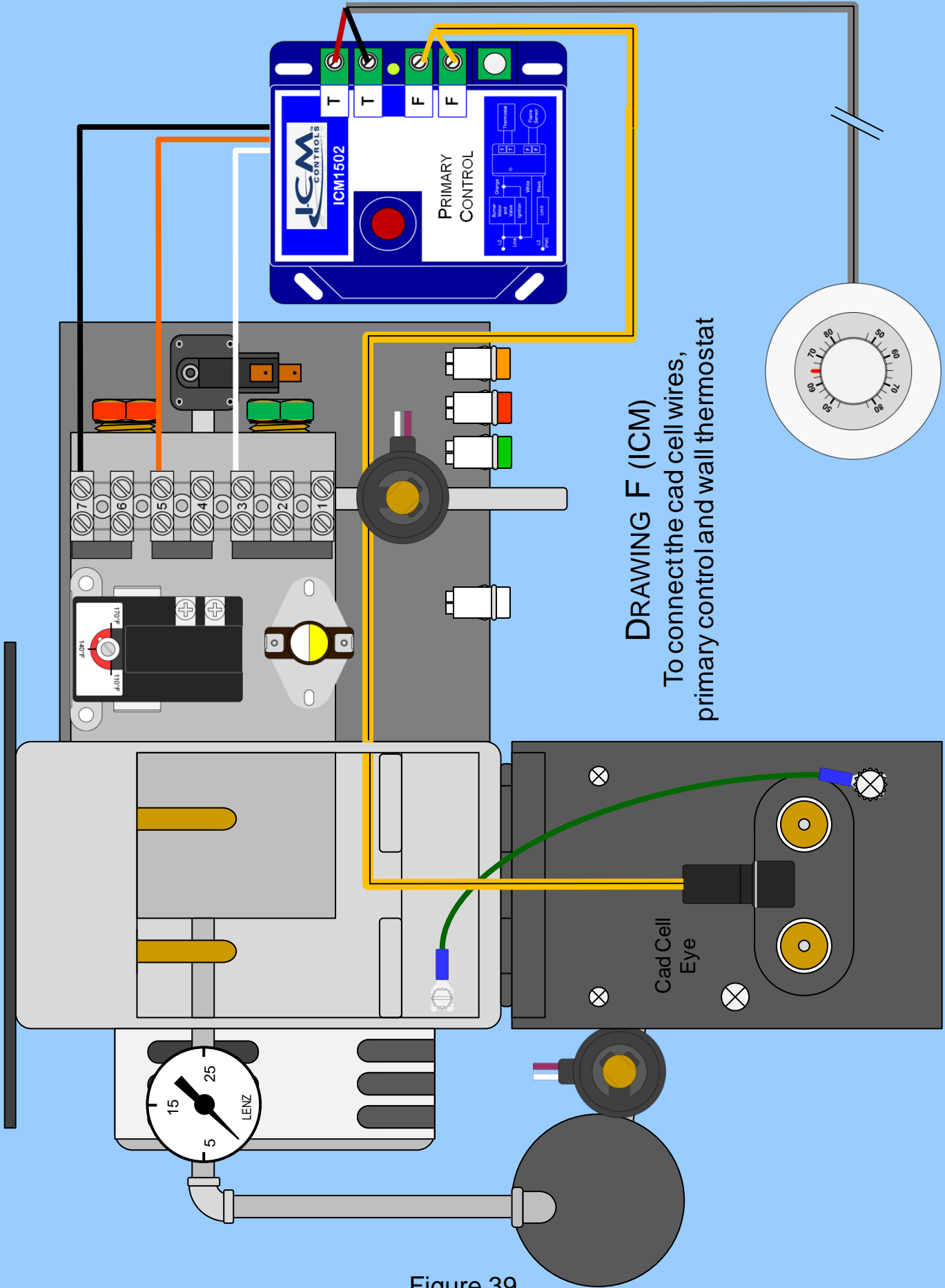

Figure 37



DRAWING F
 To connect the cad cell wires,
 primary control and wall thermostat

Figure 38



DRAWING F (ICM)
 To connect the cad cell wires,
 primary control and wall thermostat

Figure 39

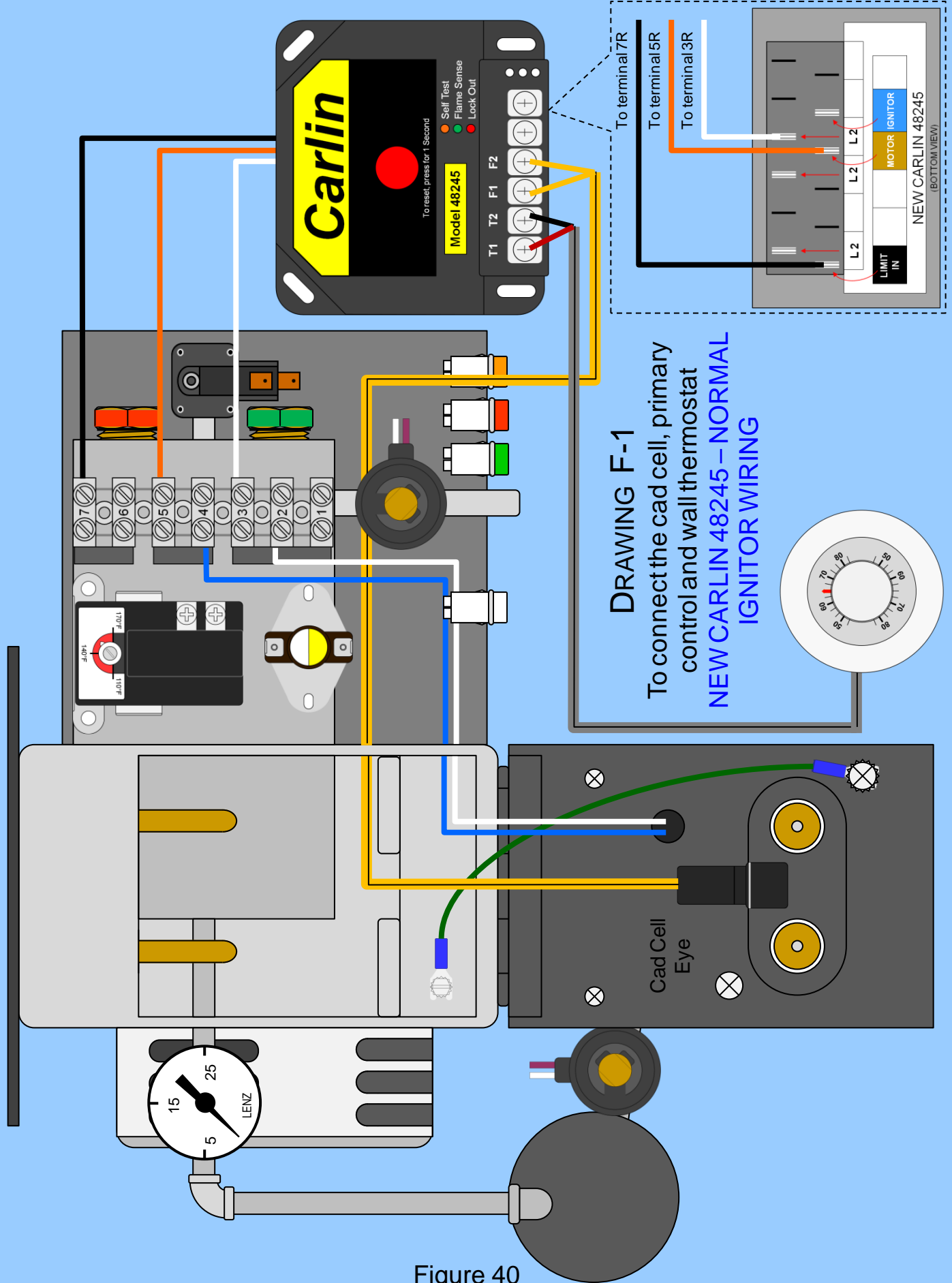

DRAWING F-1
 To connect the cad cell, primary control and wall thermostat
NEW CARLIN 48245 – NORMAL IGNITOR WIRING

Figure 40

Air / Oil Pre-Heater Cartridges

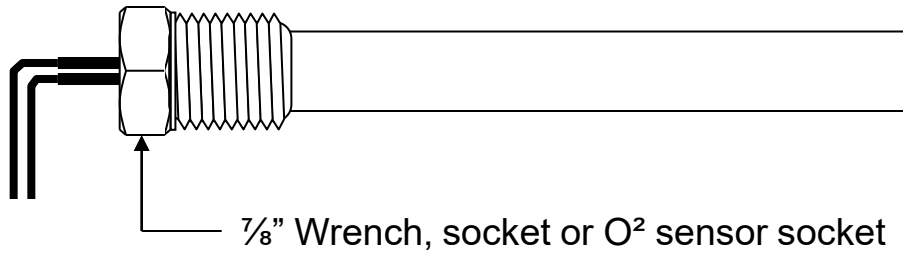

To test with ohm meter:

Heater lead to heater lead should read within 10% of values listed below = good cartridge

Under value or an "open" reading = bad cartridge – replace

High reading = may be failing - replace

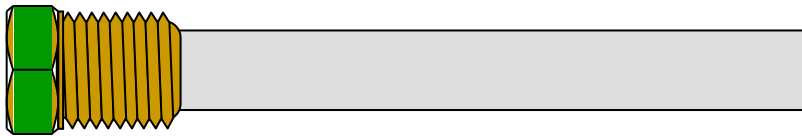

50 watt Oil Pre-heater 288 +/- 10% = 259-316 ohms
Kagi Model S250 Burners (HW150/250)

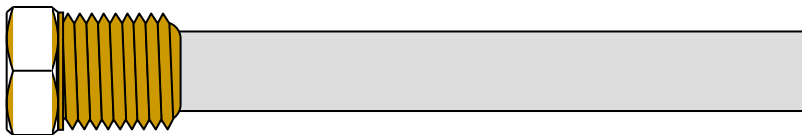

100 watt Oil Pre-heater 144 +/- 10% = 130-158 ohms
Kagi Model S500 Burners (HW350)

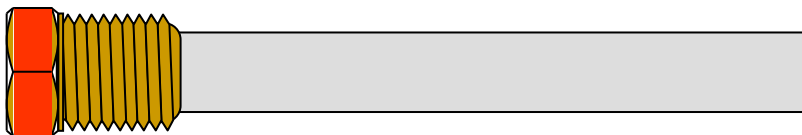

250 watt Air Pre-heater 58 +/- 10% = 52-63 ohms
Kagi Model S250 & S500 Burners

Figure 42

HEATWAVE 150 / 250 PARTS

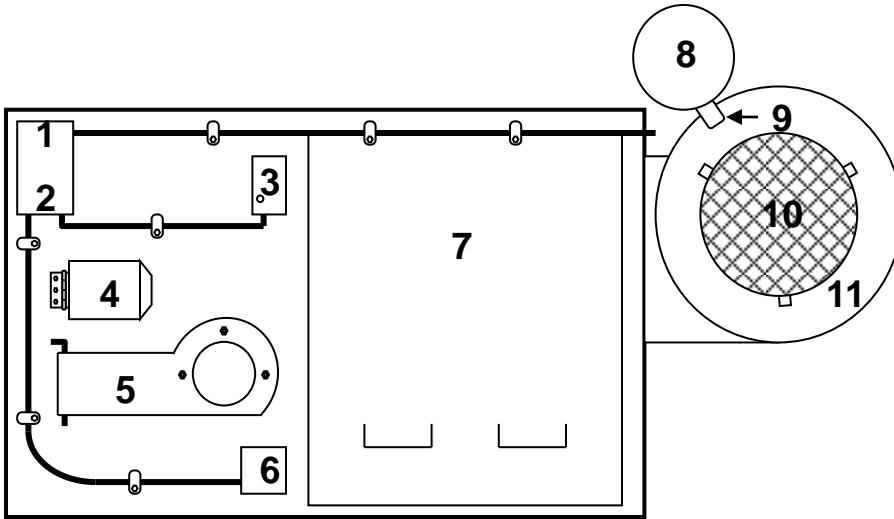

- | | |
|------------------------|---------------------------------------|
| 1. Breaker Box | 10. Blower screen |
| 2. 25A Breaker | 11. Blower |
| 3. Fan & Limit Switch | 12. Drive Pulley |
| 4. Inspection Door | 13. Driven Pulley |
| 5. Swing-out Bracket | 14. Blower Guard |
| 6. 4 X 4 Junction Box | 15. Belt |
| 7. Shell Cleanout Door | 16. Louvres |
| 8. Blower Motor * | 17. Lt. Pot Cleanout Door (not shown) |
| 9. Motor Mount Bracket | 18. Rt. Pot Cleanout Door (not shown) |

Note: For burner parts see Kagi manual

* **DO NOT** replace blower motor with farm duty or manual reset model

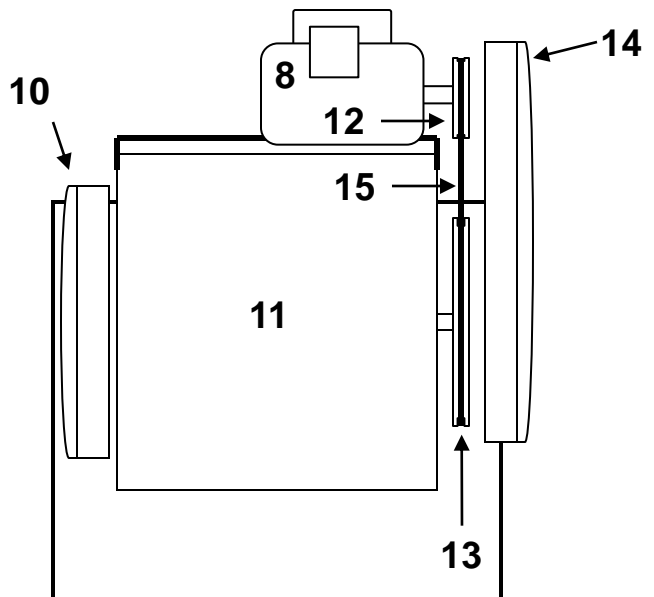
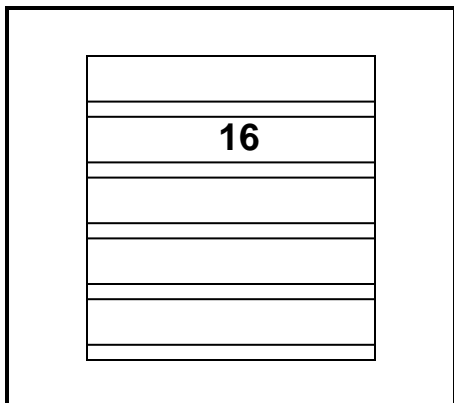
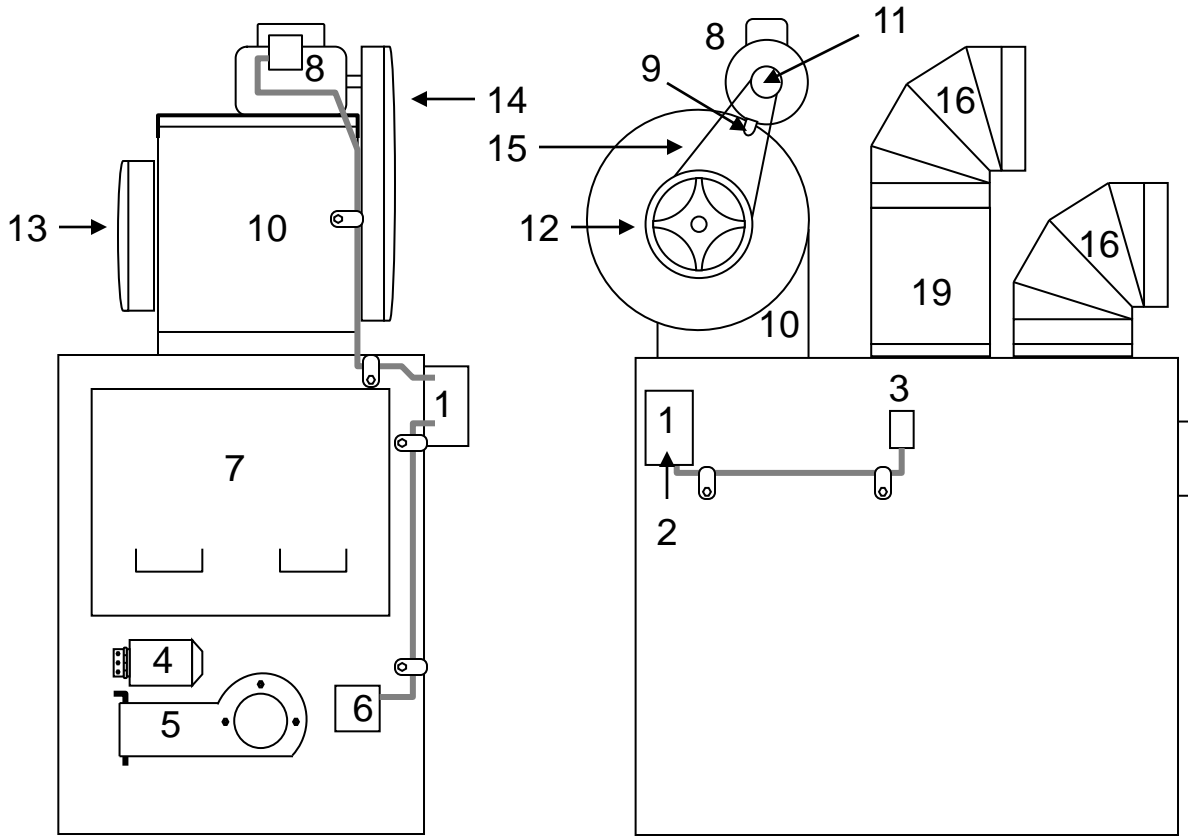

Figure 43

HEATWAVE 350 PARTS



Note: For burner parts see Kagi manual

- | | |
|----------------------------------------------------------|-----------------------------------------|
| 1. Breaker Box | 10. Blower |
| 2. 25A Breaker | 11. Drive Pulley |
| 3. Fan & Limit Switch | 12. Driven Pulley |
| 4. Inspection Door | 13. Blower Guard |
| 5. Swing-out Bracket | 14. Belt Guard |
| 6. 4 X 4 Junction Box
(burner cord safety disconnect) | 15. Belt |
| 7. Shell Cleanout Door | 16. 12" Elbow |
| 8. Blower Motor | 17. Front Pot Cleanout Door (not shown) |
| 9. Motor Mount Bracket | 18. Rear Pot Cleanout Door (not shown) |
| | 19. 12" X 12" Elbow Extension |

Figure 44

HEATWAVE CLEANING

Caution: Wear industrial dust mask and protective clothing.

Refer to section 7.06 "Seasonal Cleaning" for more information.

1. Turn thermostat to off or set below room temperature and allow furnace to cool completely.
2. Disconnect power from furnace, turn unit breaker to off.
3. Disconnect burner power cord, thermostat wires, air and oil lines and remove burner.

Note: Remove sheet metal screws from access panels prior to panel removal.

4. Remove chimney flue, clean and inspect.
5. Remove left and right shell access panel by lift upward and pulling out.

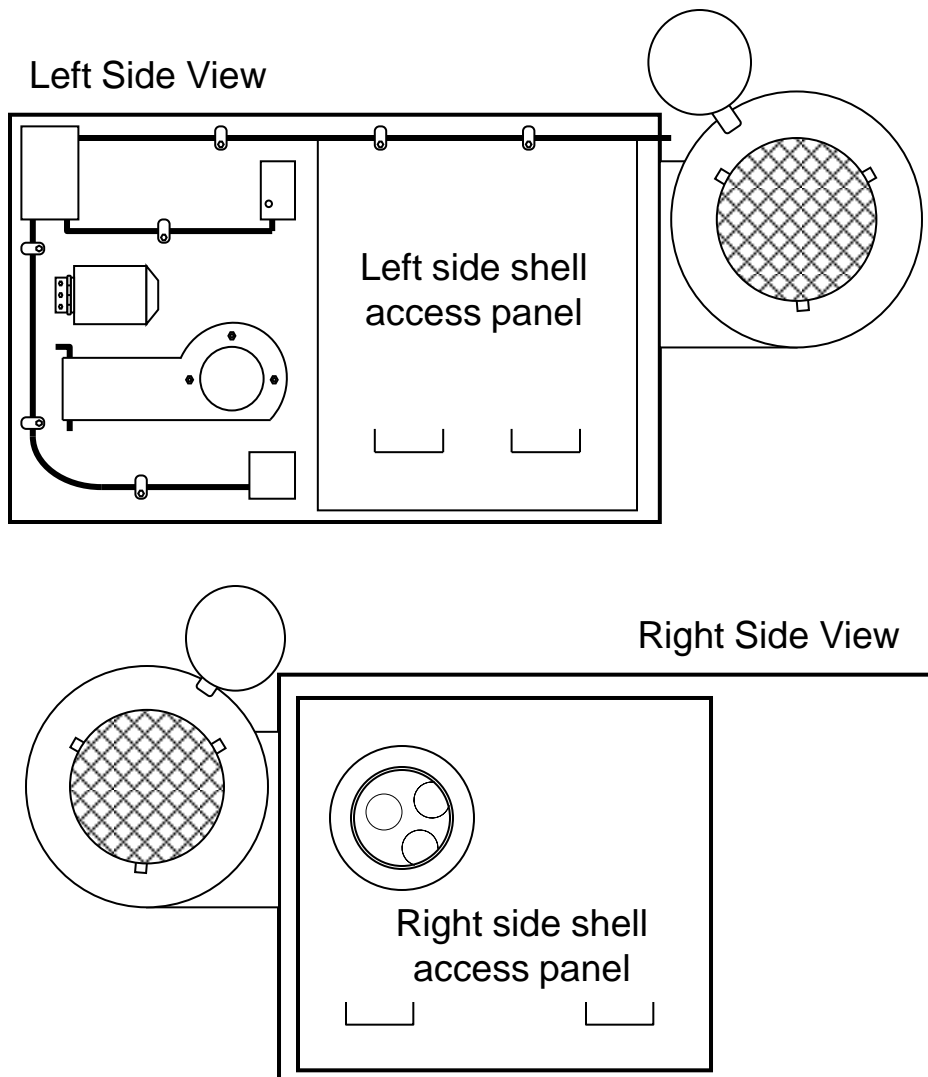

Figure 45

6. Loosen the brass nuts and clamps around left and right clean-out doors.
7. Remove center nut form right side (chimney) door.
8. Remove left and right clean-out doors to expose exchanger tubes and combustion chamber.
9. Clean all dust and residue with a shop vac. Gentle brushing may be required to remove dust and build up.
10. Check for “clinkers” and other build-up by the burner tube.
11. Inspect fiber gasket material on the clean-out doors and the left side tube area, replace as required.
12. Assembly is the reverse of the disassembly.

Note: Replace the doors carefully, making sure of a good seal. Light tapping around the perimeter of the doors with a mallet or dead blow hammer will help to ensure a good seal. There should be NO combustion chamber air leaks.

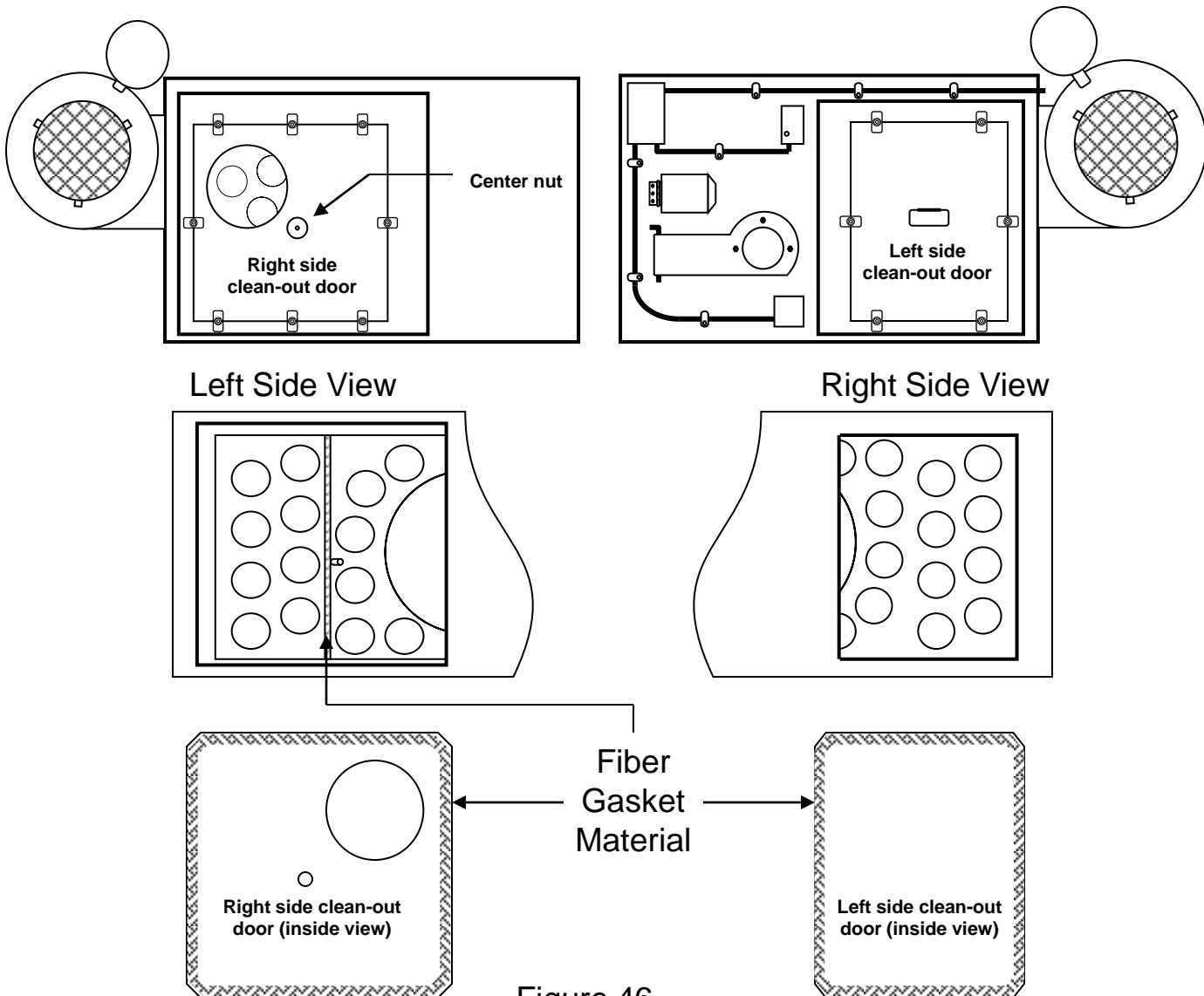

Figure 46

**DO NOT OPERATE WITH
BELTGUARD REMOVED**

**CAUTION
HOT**



! **WARNING:** Cancer and Reproductive Harm - www.P65Warnings.ca.gov

WASTE OIL SPECIFICATIONS



CAUTION: Never burn Gasoline, Cleaning Solvents, printing fluid, brake fluid or any flammable hydrocarbons in the burner. Do not attempt to burn crude oil or garbage.

FUEL USE: # 1 & # 2 Fuel Oil, used (ATF) transmission oil and used motor oils up to 50 S.A.E.

FIRING RATE: Never exceed 1.3 GPH on the model HW150, 2.0 GPH on the model 250 and 3.25 GPH on the model HW350

ELECTRICAL: Furnace is wired for 115 Volt, 60 Hz, with a 24 Volt thermostat. Use copper wire. Provide a separate 25 Amp service to the furnace. Meet National Electrical Code NFPA # 70 and all state and local codes.

Figure 47



CAUTION

Minimum clearance to combustible material is 12" from the side walls, 18" from the top. If floor mounted, set on a non-combustible flooring material. Do not block or have anything obstructing the incoming air at the blower.

The minimum circuit amperage is 10 amp.

The maximum rating of circuit protective device is 25 amps.

Rev. 1

Use copper conductors only.

Do not obstruct the outlets on the heaters. These are designed for maximum output. For duct connection maintain a lower static pressure in duct than in heater.

START UP PROCEDURE

1. Turn off electrical supply.
2. Fill the fuel supply tank above the fuel supply check valve.
3. Check for proper chimney draft. (.02)
4. Check the combustion air setting on the burner.
5. Turn main electrical service on.
6. Push reset button on the primary for three seconds.
7. Prime fuel supply.
8. Adjust air pressure regulator to 12 PSI or above.
9. Set toggle switch to "Pre-heater On" if you are burning waste oil, leave off if you are burning regular fuel oil.
10. Wait for "Green Light" plus 10 minutes to preheat the oil to operating temperature.
11. Turn up thermostat, burner should fire. (Failure - see troubleshooting)
12. Check air pressure.
13. Adjust flame length by adjusting oil pressure and air band. Flame should reach $\frac{2}{3}$ - $\frac{3}{4}$ of the way across heat exchanger.

 **WARNING**

 **FIRE AND EXPLOSION HAZARDS** 

CAUTION: Never burn gasoline, cleaning solvents, paint thinner, brake fluid or any flammable hydrocarbons in the burner. Do not attempt to burn crude oil or garbage.

FUEL USE: # 1 & # 2 fuel oil, used automatic transmission fluid (ATF) and used crankcase oils up to 50 S.A.E.

 **CAUTION**

WHEN OPENING INSPECTION DOOR

PORT MAY BE HOT

OPEN DOOR SLOWLY

WEAR SAFETY GLASSES

KEEP FACE AWAY

PROTECT HANDS

Figure 49